

SERVICE MANUAL

7.62-mm Kalashnikov Rifle (AK)



TABLE OF CONTENTS

PAGE

GENERAL INFORMATION

Purpose and characteristics of the automatic rifle	1
Brief description of the construction of the automatic rifle	1

PART ONE

CONSTRUCTION, FUNCTIONING, DISASSEMBLY, ASSEMBLY, AND INSPECTION OF THE AUTOMATIC RIFLE

CHAPTER 1. PARTS AND MECHANISMS OF THE AUTOMATIC RIFLE

1. Barrel	5
2. Receiver	10
3. Sights	19
4. Bolt	22
5. Operating rod	27
6. Return mechanism	31
7. Firing and trigger mechanism	33
8. Receiver cover	40
9. Gas tube and hand guard	42
10. Pistol grip	42
11. Fore end	45
12. Butt	45
13. Magazine	51
14. Spare parts and accessories	53

CHAPTER 2. FUNCTIONING OF AUTOMATIC RIFLE

15. Position of parts before loading	57
16. Functioning of parts during loading	60
17. Functioning of parts during semiautomatic fire	63
18. Functioning of parts during full automatic fire	68
19. Functioning of parts during unloading	69

CHAPTER 3. DISASSEMBLY AND ASSEMBLY

20. General instructions	71
21. Field stripping	71
22. Assembly after field stripping	75
23. Detail stripping	77
24. Assembly after detail stripping	81
25. Disassembly of the magazine	85
26. Assembly of the magazine	85
27. Disassembly and assembly of the automatic rifle in the repair shop	88

CHAPTER 4. INSPECTION OF THE AUTOMATIC RIFLE	
28. General	93
29. Daily inspection of the automatic rifle by the soldier	93
30. Inspection of the automatic rifle, assembled -	94
31. Inspection of the automatic rifle, disassembled	98
32. Inspection of the magazine	105
33. Inspection of the accessories	105

PART TWO
FIELD SERVICE AND USE OF THE AUTOMATIC RIFLE

CHAPTER 5. PREPARATION OF THE RIFLE FOR FIRE AND HANDLING OF THE RIFLE	
34. General	107
35. Preparation of the automatic rifle for fire --	108
36. Loading the magazine	108
37. Loading the rifle	109
38. Setting the sights	109
39. Firing	109
40. Changing the magazine	111
41. Cessation of fire and preparing the rifle for further fire	111
42. Setting the rifle on safety	111
43. Unloading the rifle	112

CHAPTER 6. CAUSES OF FAILURE OF THE RIFLE	
44. General procedure for preventing and eliminating stoppages	113
45. Characteristic malfunctions and methods for clearing them	114

CHAPTER 7. CHECK OF ACCURACY AND ADJUSTMENT OF AUTOMATIC RIFLE	
46. Procedure for adjusting rifle	117
47. Characteristic defects of the rifle affecting accuracy	121

CHAPTER 8. CLEANING AND LUBRICATION OF THE AUTOMATIC RIFLE	
48. Cleaning and lubrication of automatic rifles in use	123
49. Use of the automatic rifle in winter	131

50. Use of the automatic rifle in areas with high temperatures and sandy terrain	132
51. Cleaning and lubricating rifles in preparation for extended storage	133

CHAPTER 9. STORAGE OF AUTOMATIC RIFLES	
52. Storage of rifles in units	135
53. Storage of rifles in division and corps depots ..	136

PART THREE
AMMUNITION

CHAPTER 10. SERVICE AND TRAINING AMMUNITION	
54. General	137
55. Service ammunition and its use	137
56. Construction of service ammunition	139
57. Action of special purpose bullets	140
58. Training ammunition, purpose and construction	140

CHAPTER 11. PACKING AND STORAGE OF AMMUNITION	
59. Packing of ammunition and markings on packaging	141
60. Storage of ammunition	143

APPENDIX I. TABLE OF CHARACTERISTICS OF KALASHNIKOV AUTOMATIC RIFLE WITH WOODEN STOCK	145
---	-----

APPENDIX II. GUN DATA CARD	147
----------------------------------	-----

GENERAL INFORMATION

PURPOSES AND CHARACTERISTICS OF THE AUTOMATIC RIFLE

The 7.62-mm Kalashnikov automatic rifle (AK) (fig. 1) is a powerful individual automatic weapon designed to destroy enemy personnel at short distances.

The rifle can be employed for both semiautomatic and automatic fire. The rifle is designed basically for full automatic fire.

When firing automatic fire in short bursts, the rifle is capable of destroying collective and individual targets at ranges of up to 500 meters. The rifle can be fired most effectively at ranges of up to 300 meters.

In firing the rifle on semiautomatic fire, best results are obtained at ranges of up to 400 meters. Well-trained riflemen can fire aimed semiautomatic fire at ranges of up to 600 meters. The bullet retains a lethal effect at ranges of up to 1500 meters.

Deliverable rate of fire:

- 90 to 100 rounds per minute in short bursts;
- up to 40 rounds per minute in semiautomatic fire.

The rifle fires 7.62-mm rounds M1943.

The principal characteristics of the automatic rifle are listed in table form in Appendix I.

BRIEF DESCRIPTION OF THE CONSTRUCTION OF THE AUTOMATIC RIFLE

The 7.62-mm Kalashnikov automatic rifle is a gas-operated weapon, in which the gas is channeled through a special port in the stationary barrel and reacts on a piston.

The bore is sealed by rotation of the bolt and engagement of the bolt locking lugs with locking lugs on the receiver.

The rifle is fed from a curved box magazine with a capacity of 30 rounds.

The rear sight is of the curved ramp type, and is designed for fire of up to 800 meters.

The firing mechanism is of the hammer type, and is actuated by means of a spring. The rifle is equipped with a selector for changing from semiautomatic fire to full automatic and the reverse.

The selector also acts as a safety.

The rifle is provided with either a wooden or a folding metal stock. In the traveling position, in movement on skis, and in parachute jumps, the metal stock is folded beneath the receiver (fig. 2). As a rule, the rifle is fired with the stock unfolded; however, if time does not permit the unfolding of the stock, the rifle may be fired with the stock folded.

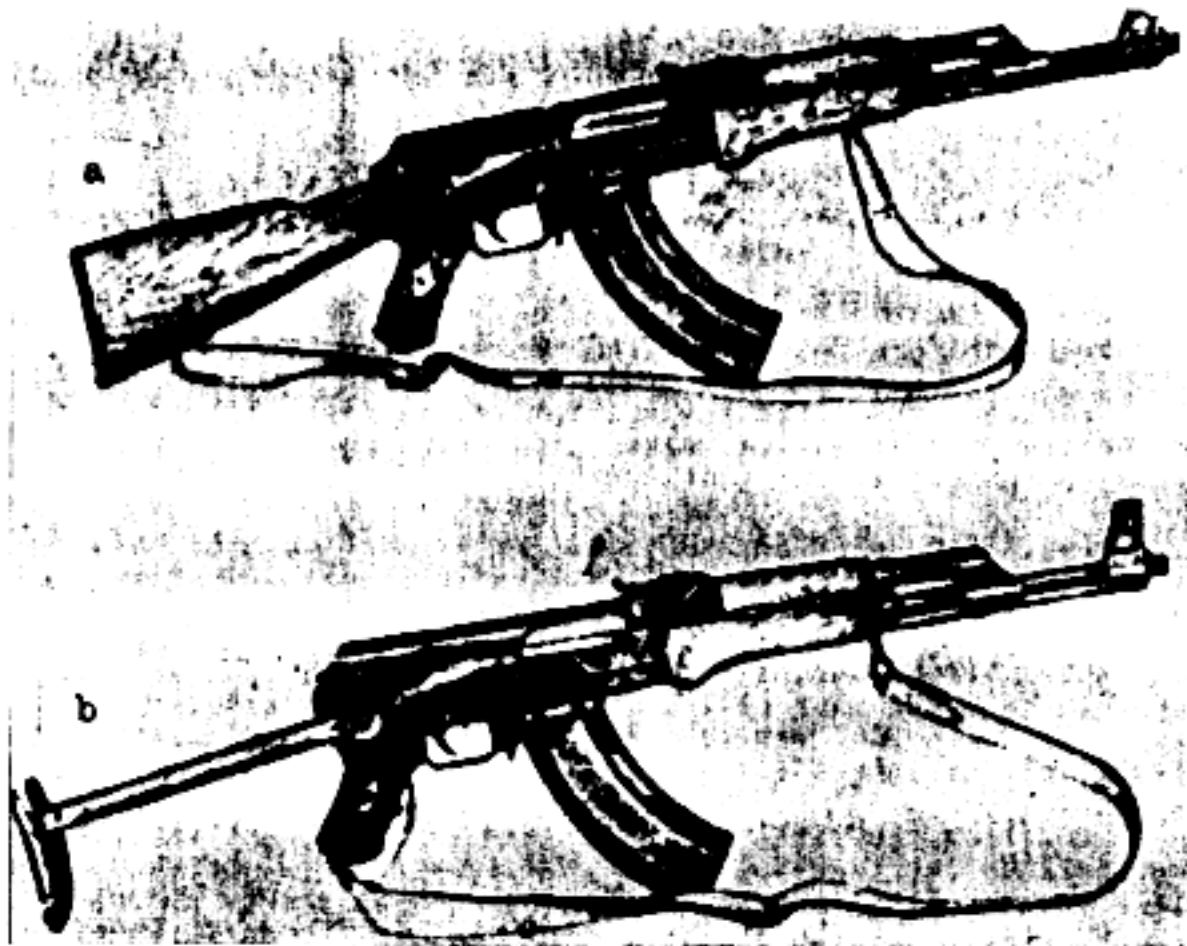

Figure 1. General view of the Kalashnikov automatic rifle.

- a. With wooden stock.
- b. With folding metal stock.



Figure 2. Kalashnikov automatic rifle with folding metal stock in folded position.

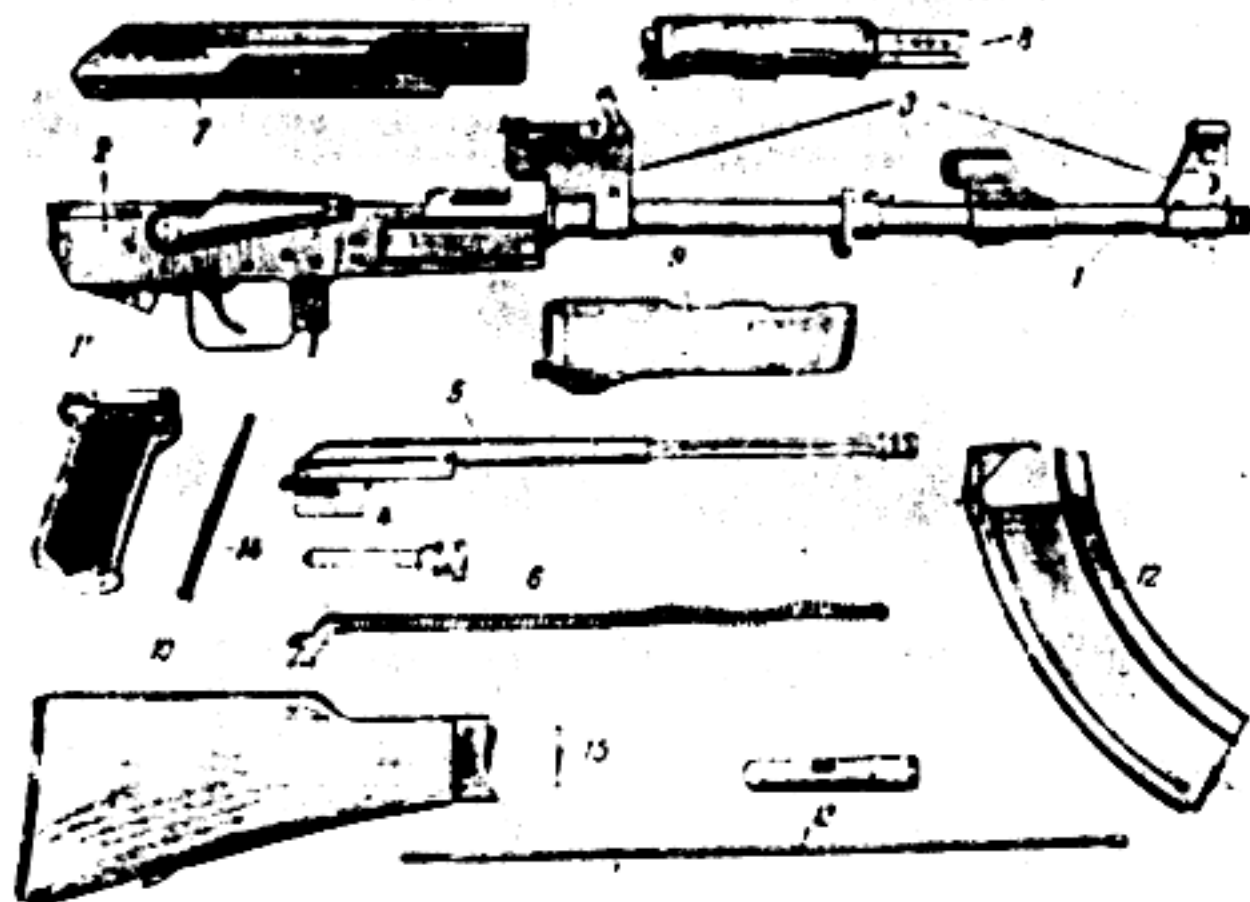

Figure 3. Principal parts of the Kalashnikov automatic rifle.

- 1 - barrel (1-10); 2 - receiver (assy. 1-1);
- 3 - sights; 4 - bolt (assy. 3-2); 5 - operating rod (assy. 3-1); 6 - return mechanism (assy. 4); 7 - receiver cover (0-1); 8 - gas tube and hand guard (assy. 1-12); 9 - fore end (assy. 6); 10 - stock (assy. 5); 11 - pistol grip (assy. 8); 12 - magazine (assy. 7); 13 - cleaning rod and accessory case; 14 - pistol grip screw (0-19); 15 - stock pin.

PART ONE

CONSTRUCTION, FUNCTIONING, DISASSEMBLY, ASSEMBLY, AND INSPECTION ON THE AUTOMATIC RIFLE

CHAPTER 1

PARTS AND MECHANISMS OF THE AUTOMATIC RIFLE

The 7.62-mm Kalashnikov automatic rifle consists of the following principal parts and mechanisms (fig.3)*: barrel (1), receiver (2), sights (3), bolt (4), operating rod (5), return mechanism (6), firing and trigger mechanisms, receiver cover (7), gas tube (8) with hand guard, fore end (9), stock (10), with pin (15), pistol grip (11) with screw (14), and magazine (12).

In addition, the rifle is provided with accessories (13) for cleaning and lubricating, disassembly and assembly.

1. BARREL

The barrel (fig.4) serves to direct the flight of the bullet. To the barrel are attached the barrel bushing (1), the front sight base (2), the gas cylinder (3), the fore end band (4), and the rear sight base (5).

The barrel is provided with exterior threads (6) for installing the device for firing blank cartridges; there are cylindrical portions for the front sight base, the gas cylinder, the fore end band, and the rear sight base. A shoulder (7) serves as a support for the barrel when inserted into the receiver. At the rear of the barrel there is a reinforced section (8) over the chamber, and a thread (9) for the receiver.

On the cylindrical portions of the barrel for the front sight base, the gas cylinder and rear sight base, there are semicircular recesses (10, 11 and 12) for pins; on the cylindrical portion for the fore end band there is a semicircular recess (13) for the fore end band lock.

The interior of the barrel consists of the bore, made up of the chamber (14) and the rifled portion (15).

The chamber is connected to the rifled portion by means of a passage (16) which assures smooth engagement of the bullet with the rifling. On the breech face of the chamber there is a

*The following description is of the model with wooden stock. Differences between this model and the model with metal stock are noted later.



Figure 4. Barrel (A - overall view; B - section).

1 - barrel bushing (0-14); 2 - front sight base (1-30); 3 - gas cylinder (1-29); 4 - fore end band (assy. 1-11); 5 - rear sight base (1-21); 6 - thread for device for firing blank cartridges; 7 - supporting shoulder for barrel; 8 - barrel reinforce; 9 - thread for connecting barrel to receiver; 10 - semi-circular recesses for front sight base pins; 11 - semicircular recesses for gas cylinder pins; 12 - semicircular recesses for rear sight base pins; 13 - semicircular recess for fore end band lock; 14 - chamber; 15 - rifled portion; 16 - passage; 17 - bevel; 18 - rifling; 19 - gas port.

ramp (17) for guiding the bullet into the chamber. The rifled portion of the bore has four grooves (18), which originate at the left and continue in a counterclockwise direction. The grooves serve to impart rotary motion to the bullet.

The portions between the grooves are called the lands. The distance between two opposite lands is called the caliber, and is equal to 7.62-mm. In the central portion of the barrel there is a gas port (19) for passing a portion of the gases into the gas cylinder.

The barrel bushing (fig.5) serves to protect the threads on which the device for firing blank cartridges is installed. On the exterior of the barrel bushing there is a shoulder (1) with four recesses (2) for the lock; there are also a circular groove (3) and two recesses (4). The grooves and recesses are designed to hold the hand guard when the bore is being cleaned. The barrel bushing is provided with interior threads (5) for installation on the muzzle.

The barrel bushing lock (fig.6) is located in a recess in the front sight base and consists of a lock (1), spring (2), and pin (3).

The forward edge of the lock enters one of the recesses in the barrel bushing shoulder when the bushing is installed on the barrel, thus preventing the barrel bushing from coming loose.

The lock and spring are retained in the front sight by means of a pin which enters recess (4) of the lock.

The gas cylinder (fig.7) serves to direct the gases which are passed from the bore to the piston.

On the upper portion of the gas cylinder there is a circular edge (1) for fastening the gas pipe to the hand guard; and on the lower portion there are two ports (2) for pins, and a lug (3) for the cleaning rod.

The interior of the gas cylinder is provided with a cylinder (4) into which the gases pass from the bore by means of a gas port (5). Bevel (6) on the forward face of the gas cylinder serves to guide the piston into the gas cylinder, thus preventing the piston from jamming against the face of the gas cylinder.

The gas cylinder fits on the barrel very tightly, and is locked by two pins (7).

Fore end band (fig.8) serves to lock the fore end to the barrel. It has rims (1) for the forward end of the fore end; lug (2) with port (3) for lock; forward swivel (4) for the sling; port (5) for the cleaning rod; notch (6) for the lock lever when the stop ring is locked on the barrel. Lock (7) serves to lock the fore end band on the barrel. It is provided with a lever (8) and recess (9).



Figure 5. Barrel bushing (0-14).

1 - shoulder; 2 - recess; 3 - circular groove; 4 - recesses; 5 - threads.

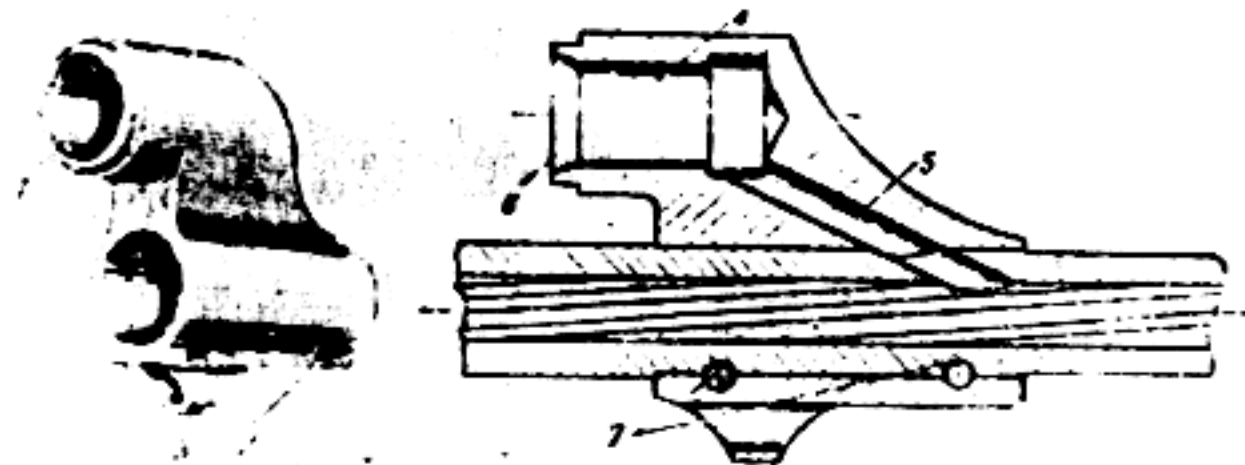

Figure 7. Gas cylinder (1-29). (Overall and sectional views)

1 - circular edge; 2 - ports for pins; 3 - lug for cleaning rod; 4 - cylinder; 5 - gas port; 6 - bevel for guiding piston; 7 - pins.

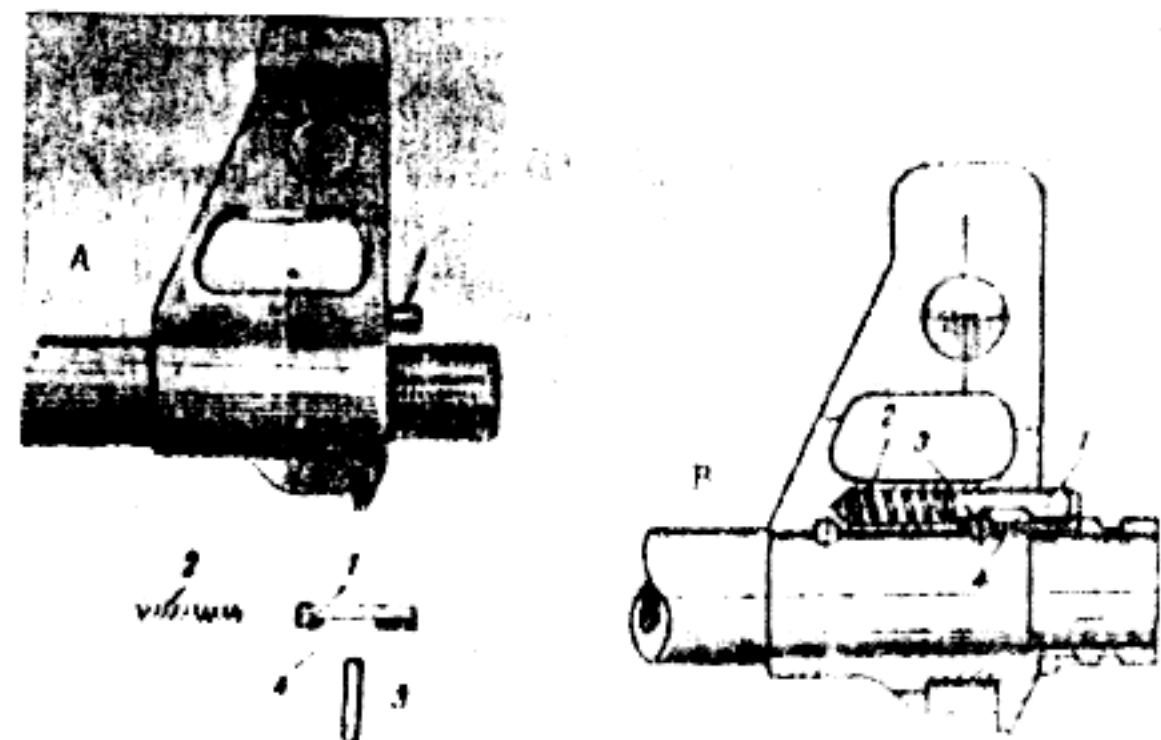

Figure 6. Barrel bushing lock.

A. Lock in assembled and disassembled views with barrel bushing removed.
B. Sectional view with bushing installed.

1 - lock (1-37); 2 - lock spring (1-38); 3 - pin; 4 - recess.



Figure 8. Fore end band with lock (assy. 1-11).

1 - rims; 2 - lug; 3 - port for lock; 4 - forward swivel; 5 - port for cleaning rod; 6 - notch for lock lever; 7 - lock (1-28); 8 - lock lever; 9 - recess.

The fore end band is locked on the barrel when the lock lever is turned to the rear, and the round portion of the lock enters recess (13) in the barrel (see fig. 4). The fore end band can be moved along the barrel when the lever is moved forward and the lock recess is turned towards the barrel.

2. RECEIVER

The receiver (fig. 9) serves to connect the parts of the automatic rifle and to direct the motion of the bolt and the operating rod. On the top of the receiver there are guides (1) for guiding the operating rod. The guides are provided with recesses (2) for passing the bolt lugs and recesses (3) for passing the operating rod lugs when the operating rod and bolt are being connected to the receiver. The right guide is provided with a semicircular recess (4) and bevel (5) for preventing the cartridge cases from striking the receiver in extraction.

To the bottom of the receiver are fastened a safety bracket (6) and pistol grip base (7).

In addition, in the bottom of the receiver there is an opening (8) for the magazine, and an opening (9) for the trigger.



On the right wall of the receiver there is a lug (10) and a lug (11) for reinforcing the receiver wall; lug (12) for limiting the safety lever; recesses (13 and 14) for stopping the selector; opening (15) for installing the selector in the receiver (in the round portion of the opening is placed the right trunnion of the selector lever).

Near recess (13) are the letters AV, which correspond to the selector setting for automatic fire, and near recess (14) are the letters OD*, which correspond to the selector setting for semiautomatic fire.

On the left wall of the receiver there is a lug (16) for reinforcing the upper portion of the receiver, an opening (17) for the left trunnion of selector lever. In the forward portion of the left wall of the receiver are the serial number of the automatic rifle and the name of the manufacturer.

In the right and left walls of the receiver there is an opening (18) for the hammer pin, opening (19) for the trigger pin, and opening (20) for the automatic trigger pin.

In the top portion of the receiver (fig. 10) there is a groove (21) for the rear portion of the rear sight base; lug (22) in which the left locking lug is formed; shoulder (23)

*The latin letters AV appear as Cyrillic AB on the Soviet model, as  on the Chicom model, and as latin L on the Chicom "export" model. The latin letters OD appear as Cyrillic OA on the Soviet model, as  on the Chicom model, and as latin O on the Chicom "export" model.

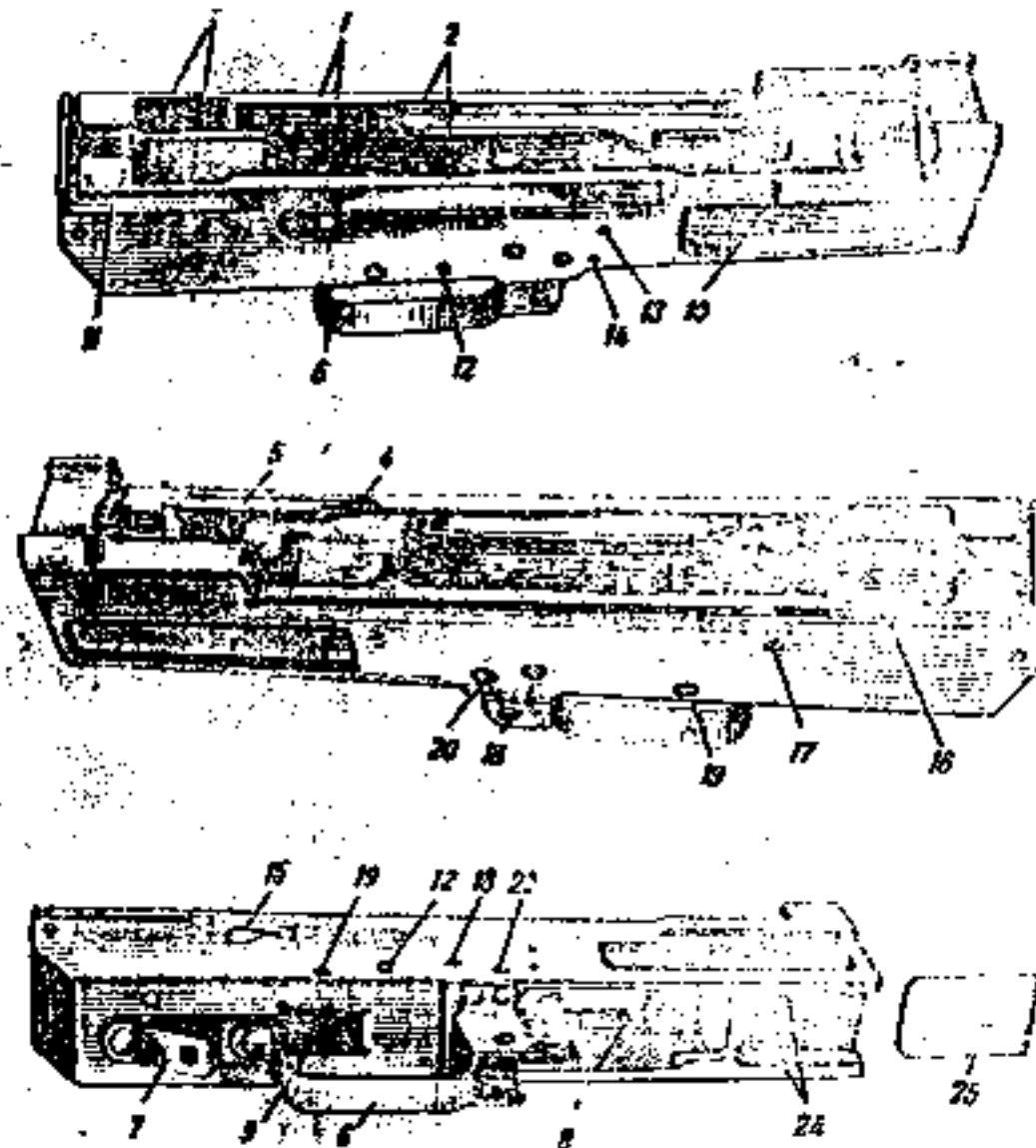

Figure 9. Receiver (assy. 1-11).

A. Right side; B. Left side; C. Bottom.

1 - guides; 2 - recesses for passing bolt lugs; 3 - recesses for passing operating rod lugs; 4 - semicircular recess; 5 - bevel; 6 - safety bracket; 7 - pistol grip base; 8 - magazine opening; 9 - trigger opening; 10, 11 - lugs for reinforcing receiver walls; 12 - lug for limiting the safety lever (1-20); 13, 14 - recesses for stopping the selector; 15 - opening for selector lever; 16 - lug for reinforcing upper portion of receiver; 17 - opening for left trunnion of selector lever; 18 - opening for hammer pin; 19 - opening for trigger pin; 20 - opening for full automatic sear; 24 - recess for fore end; 25 - cover (1-7).

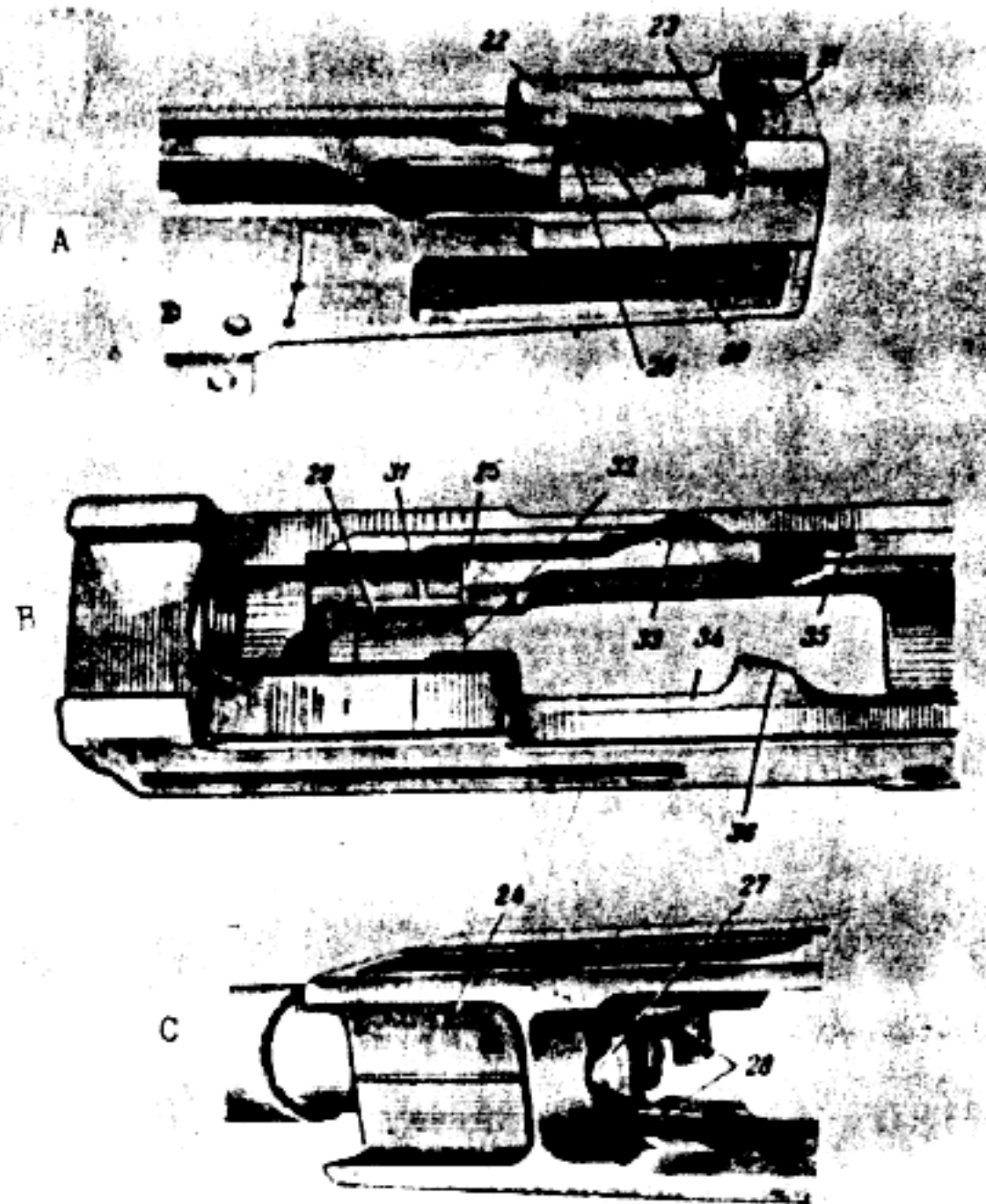

Figure 10. Forward portion of receiver.

A. Rifled side view; B. Left side view;
C. Bottom.

21 - groove for the rear sight base; 22 - lug; 23 - shoulder for limiting motion of operating rod; 24 - recess for fore end; 25 - right locking lug; 26 - left locking lug; 27 - recess in which forward portion of magazine is attached; 28 - shoulders for limiting movement of magazine; 29 - cam surface (1-9); 30 - cam surface screw bevel; 31 - right edge of cam surface; 32 - cam surface guide end; 33 - right guide; 34 - left guide; 35 - groove for full automatic sear lever; 36 - extractor.

which limits the motion of the operating rod and absorbs blows of the operating rod when the latter moves to the extreme forward position.

In the forward portion the receiver is provided with a recess (24) with grooves for cover (25) (see fig. 9), which closes this recess.

Recess (24) forms a recess for holding the fore end. On the inside of the forward portion of the receiver there is thread for attaching the barrel; locking lugs (24 and 25) with which the bolt locking lugs engage when the bore is being sealed; recess (27) for holding the forward portion of the magazine; and shoulders (28), which limit the motion of the magazine upwards when it is being connected to the rifle, and cam surface (29), which is riveted to the receiver.

The cam surface serves to rotate the bolt a certain amount when the bore is being sealed, to limit rotation of the bolt at the end of its motion, and to guide the cartridge into the chamber.

On the cam surface there is a cam (30), which engages with the left locking lug of the bolt, for the purpose of preliminary rotation of the bolt when the bore is first being sealed.

At the end of the sealing action, rotation of the bolt is limited by the right edge (31) of the cam surface.

The edge (32) on the rear face of the cam surface guides the round into the chamber.

The interior of the receiver is provided with right guide (33) and left guide (34) for guiding the bolt. In the right guide there is a groove (35) for the upper portion of the full automatic sear lever, and in the left guide there is an extractor (36) for extracting the cartridge cases. In their forward portion, the guides have projections and a camming surface which serve to guide the cartridge as it leaves the flanges of the magazine, and semicircular recesses, which contain the central cylindrical portion of the bolt.

The receiver rear end (fig.11) is the back plate, which receives the blows from the operating rod as the latter moves to the extreme rear position.

In the upper portion of the back plate there is a groove (37) for holding the heel of the return spring guide tube and a groove (38) for the rear edge of the receiver cover; at the rear, there is a groove (39) for holding the stock and hole (40) for the stock pin.

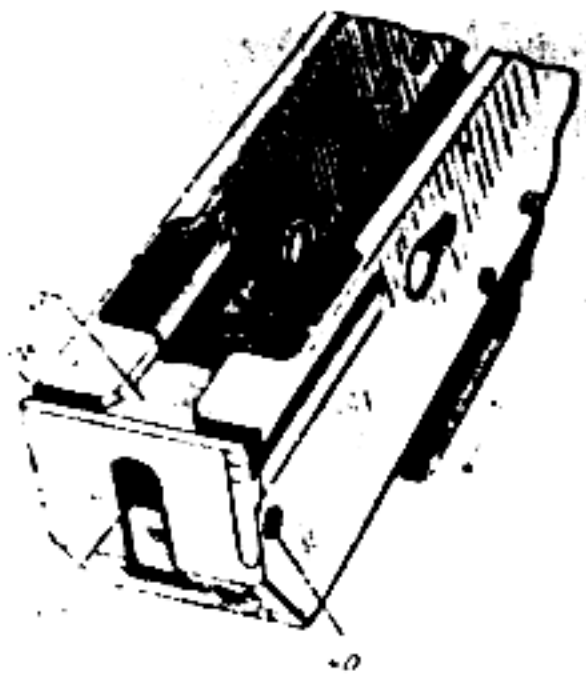

Figure 11. Rear end of receiver (back plate).

37 - groove for holding heel of guide tube; 38 - groove for rear end of receiver cover; 39 - groove for holding stock; 40 - hole for stock pin.

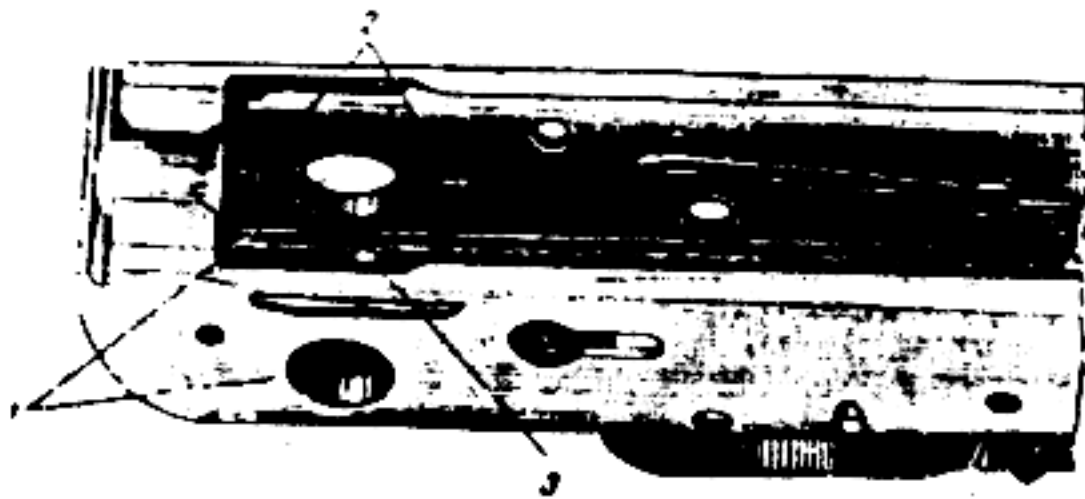

Figure 12. Rear portion of receiver of automatic rifle with folding metal stock.

1 - holes for stock pin; 2 - holes for stock catch; 3 - hole for more convenient removal of catch pin.

The receiver of the automatic rifle with folding metal stock (fig. 12) has holes (1) in the rear portion for the stock pin, holes (2) in the left wall for the stock catch, and holes (3) for convenient removal of the catch pin.

The magazine catch (fig. 13) with spring serves to hold the magazine in the receiver. It consists of a catch (1), spring (2) and pin (3).

On the catch there is a stop (4) and hole (5) for the pin.

The catch with spring is connected with the safety (trigger) guard by means of pin (3).

The upper edge of the catch is pressed forward by the spring, causing the end (6) to be engaged by the magazine stop to retain the magazine in the receiver.

There are also automatic rifles with stamped receiver (fig. 14). The stamped receiver has the following construction: An insert (1) is welded to the forward part of these receivers, and back plate (2) to the rear portion.

To the bottom of the receiver there are welded a safety (trigger) guard (3) and pistol grip base (4).

Inside the receiver there are welded guides, the upper edges of which serve as guides for the bolt, and the lower edges as a reinforcement for the receiver walls around the hole for the hammer pin.

The upper edges of the receiver are bent inward and form cam surfaces (6) for guiding the operating rod.

The insert of the stamped receiver (fig. 15) is provided with threads (1) for the barrel; shoulders (2 and 3); forward portion of bolt guides (5 and 6); extractor (7); groove (8) for the rear sight base; notch (9) for the fore end; recess (10) and shoulders (11) for holding the magazine.

The notch for the fore end is covered by the lower portion of the receiver wall.

The back plate of the stamped receiver (fig. 16) has a groove (1) for holding the heel of the return spring guide tube, groove (2) for rear edge of the receiver cover; recess (3) for holding the forward edge of the stock; two projections (4 and 5) with holes for holding the stock by means of screws.

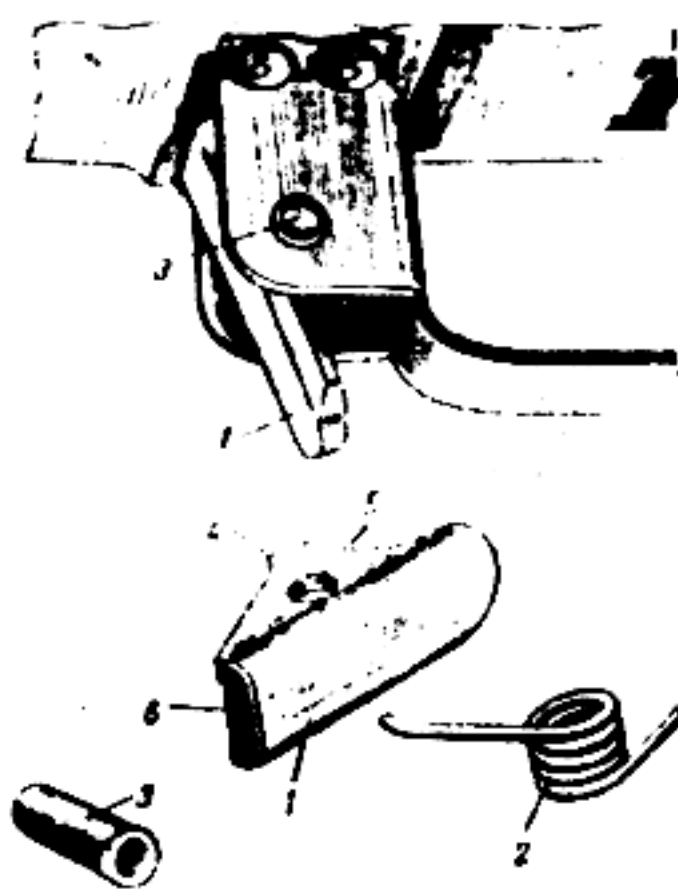

Figure 13. Magazine catch, assembled and disassembled.

1 - catch (0-11); 2 - catch spring (0-12); 3 - catch pin (0-13); 4 - catch stop; 5 - hole for pin; 6 - upper end of catch.

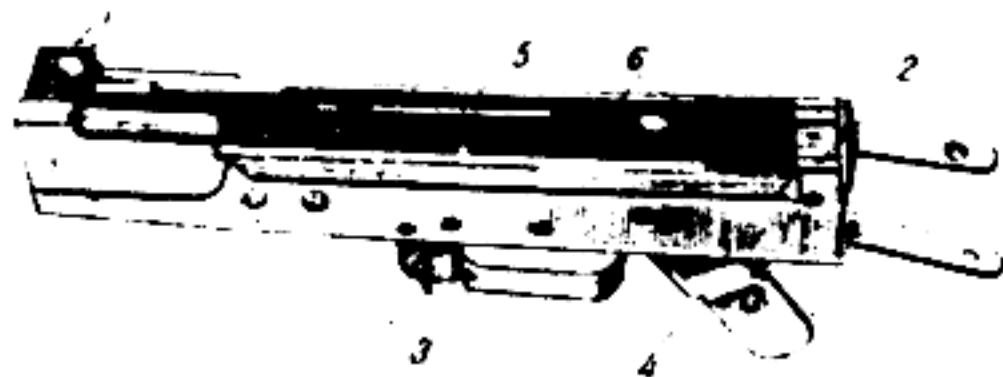

Figure 14. Stamped receiver (assy. 1-1).

1 - insert (assy. 1-7); 2 - back plate (1-3); 3 - safety (trigger) guard; 4 - pistol grip base; 5 - guide; 6 - guide surfaces.

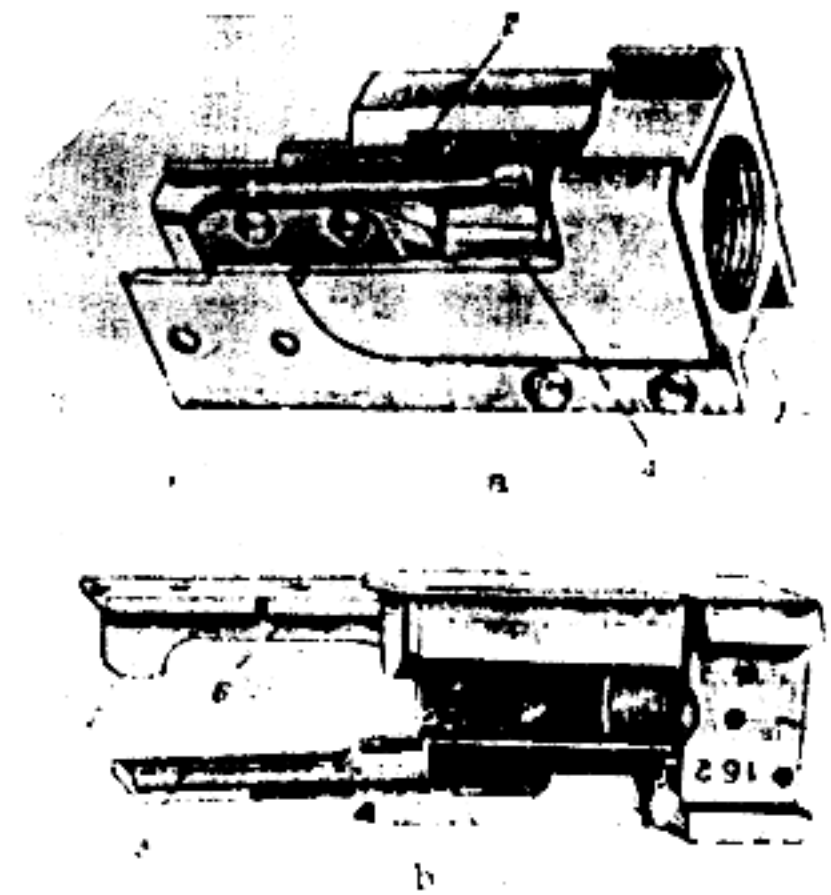

Figure 15. Insert of stamped receiver (assy. 1-7).

A. Right view; B. Top view; C. Bottom view.

1 - thread for barrel; 2, 3 - shoulders; 4 - cam (1-9); 5, 6 - guides; 7 - extractor; 8 - groove for rear sight base; 9 - notch for fore end; 10 - recess; 11 - shoulders.

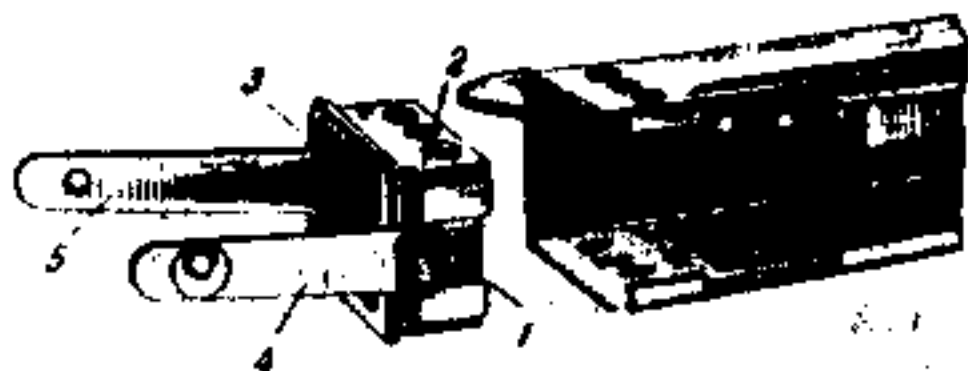

Figure 16. Back plate (1-3) of stamped receiver.

- 1 - groove for holding heel of guide;
- 2 - groove for receiver cover rear end;
- 3 - recess for holding forward edge of stock; 4, 5 - projections of back plate with holes.

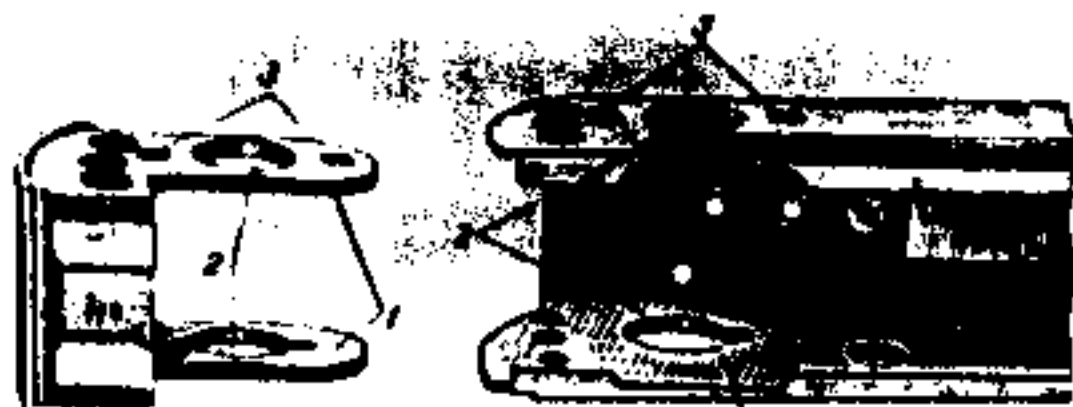

Figure 17. Back plate (1-49) of stamped receiver with folding metal stock.

- 1 - lugs; 2 - holes for stock pin; 3 - square holes for stock catch; 4 - hole for facilitating removal of stock catch pin.

In automatic rifles with stamped receiver and folding metal stock (fig. 17), the back plate has two lugs (1) with holes (2); the receiver has the same kind of holes. They hold the stock pin, and the lugs reinforce the receiver walls.

Also, in the left wall of the receiver and in the left lug there are square holes (3) for the stock catch, and in the bottom of the receiver there is a hole (4) for facilitating removal of the catch pin when the stock is being removed.

3. SIGHTS

The sights are used to aim the rifle at the target for fire at various ranges. They are mounted on the barrel and consist of the front and the rear sight.

The rear sight (fig. 18) consists of a base (1), on which there are sectors; sight leaf (2), sight leaf spring (3), slide (4); slide catch (5) and spring (6).

The sight base (fig. 19) has a lug (1), by means of which the sight is mounted on the barrel; hole (2) for the pin which holds the base on the barrel; hole (3) for the gas tube lock; hole (4) for passing the operating rod; semicircular groove (5) for holding the receiver cover plate; notch (6) and recess (7) for holding the gas tube.

The gas tube lock (8) has a lever (9), by means of which the lock is rotated; and a recess (10) for passing the rear face of the gas tube when it is being removed from and attached to the barrel.

In the closed position, the lock is stopped by a lever, on which there is a stop; the latter enters a special recess (11) in the right side of the sight base.

The sectors are integral with the sight base and are used to set the desired ranges. The sectors have a lug (13) for connecting the sight leaf.

The sight leaf (fig. 18) has odd numbers inscribed on the right side, which correspond to ranges of 100 to 700 meters, and on the left side there are inscribed numbers 2 to 8, which correspond to ranges of 200 to 800 meters. On the left side of the sight leaf is the letter "P".* This graduation is the constant (battle) setting of the sight; with this setting, the slide is located as far to the rear as possible.

The rear sight leaf has a sight bar with rectangular notch, notches (8) for the catch teeth, longitudinal notch (9) for more exact indexing of the inscribed numbers, trunnions (10) for holding the sight leaf to the sight base.

*The latin letter P appears as Cyrillic П on the Soviet and Chicom models; it appears as latin D on the Chicom "export" model.

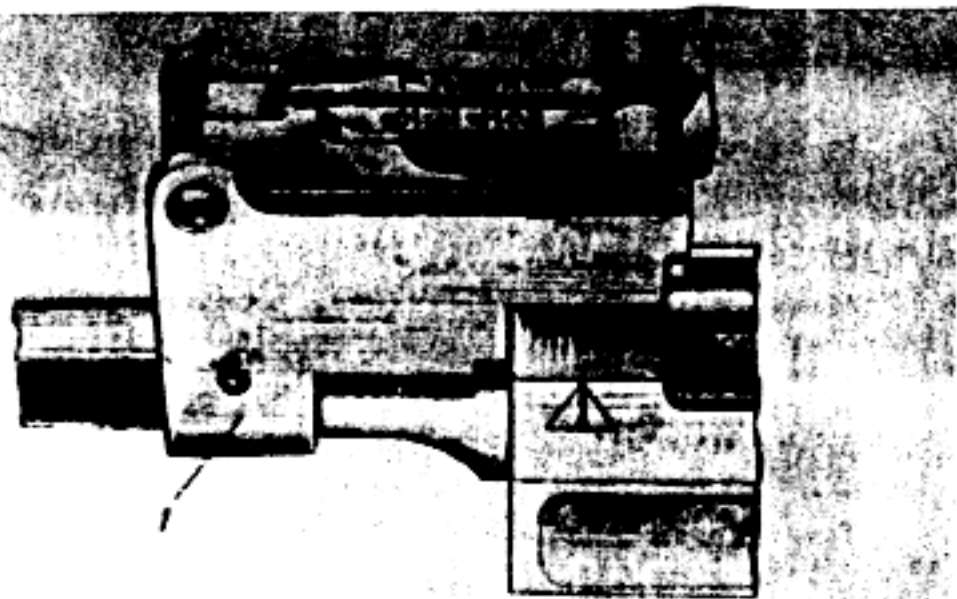

Figure 18. Rear sight, assembled and disassembled.

1 - rear sight base (1-21); 2 - sight leaf (2-1); 3 - sight leaf spring (0-23); 4 - slide (2-2); 5 - slide catch (2-3); 6 - slide catch spring (2-4); 7 - sight bar; 8 - notches for slide catch teeth; 9 - longitudinal notch; 10 - trunnions; 11 - transverse groove for connection with sight leaf; 12 - hole for catch; 13 - recess for spring catch; 14 - catch button.

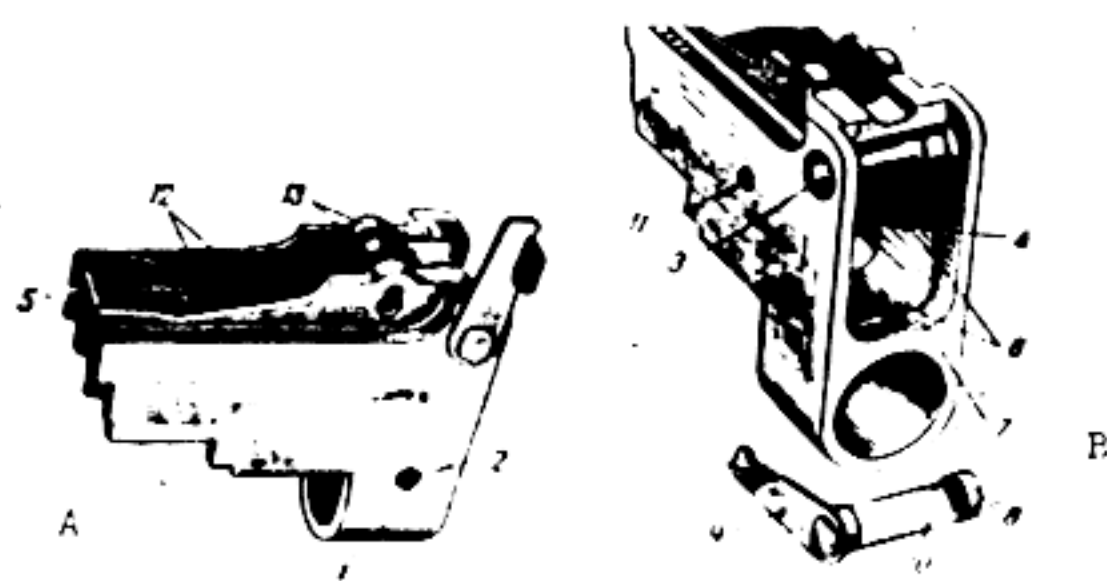

Figure 19. Rear sight base (1-21).

A. Right view; B. Front view.

1 - lug; 2 - hole for pin; 3 - hole for lock; 4 - opening for passing operating rod; 5 - semicircular groove for receiver cover; 6 - notch for gas tube; 7 - recess for gas tube; 8 - gas tube lock; 9 - lock lever; 10 - recess for passing rear face of gas tube; 11 - recess for lock; 12 - sectors; 13 - lug for connecting sight leaf.

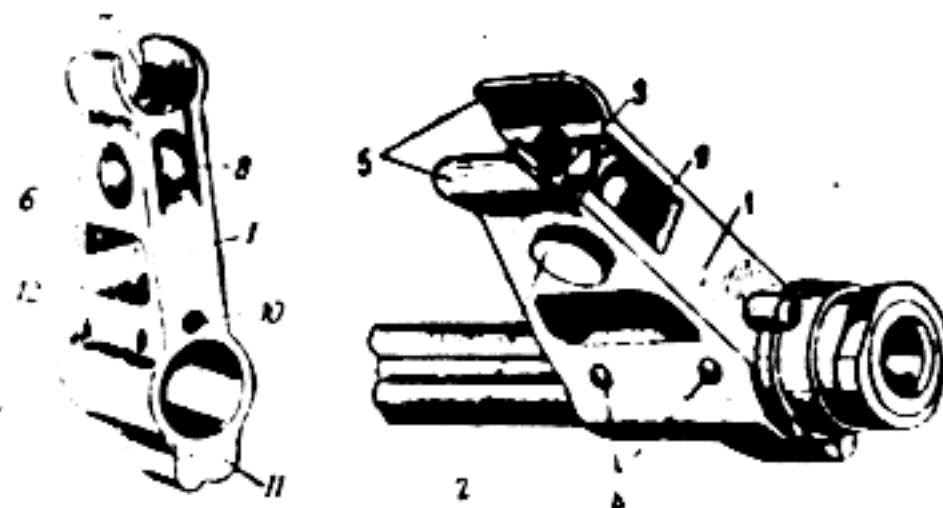

Figure 20. Front sight base, assembled.

1 - front sight base (1-30); 2 - stud (1-31); 3 - front sight (1-32); 4 - pins; 5 - front sight ears; 6 - hole for stud; 7 - oval-shaped recess for front sight; 8 - front hole; 9 - alignment index; 10 - recess for barrel bushing lock; 11 - stop with recess for cleaning rod head; 12 - hole for decreasing weight of base.

The spring (3) holds the sight leaf on a particular setting, on the sectors of the sight base.

The slide (4) has a transverse groove (11) for connecting to the sight leaf, hole (12) for the catch, and recess (13) for the catch spring.

The slide catch (5) has a button for disengaging the teeth of the catch from the notches in the sight leaf when pressed by the fingers. Catch spring (6) holds the catch teeth on the notches of the sight leaf.

The front sight base and front sight (fig. 20). The front sight (3) is threaded into the stud (2), which is located in the front sight base (1).

The front sight base is held tightly to the barrel by means of pins (4). The base is provided with protecting ears (5), transverse hole (6) for holding the stud, oval-shaped recess (7), which permits the front sight and the slide to be moved together in the base, front hole (8); on the beveled wall of the latter there is an alignment index (9). In addition, the base also has a recess (10) for the barrel bushing lock; below there is a stop (11) with a recess for holding the cleaning rod head; hole (12) for decreasing the weight.

The front sight (fig. 21) is provided with a threaded portion (1) for screwing into the stud; in the threaded portion there is a longitudinal groove (2) for the purpose of providing elasticity to prevent the sight from becoming loose; in the upper portion of the sight there are flat recesses (3) for the key.

The front sight stud (fig. 22) is used to move the front sight from side to side when the rifle is being checked for line of sighting. In it there is a threaded hole (1) for receiving the front sight and an alignment index (2), which is engraved in the base and the slide at the same time at the factory after the sights are aligned.

The front sight safety (fig. 20) protects the sight from blows and improves sighting conditions.

The sight safety is integral with the sight base. The top portion of the safety is open to permit installing the front sight by means of the key.

4. BOLT

The bolt (fig. 23) serves to push the rounds into the chamber, seal the bore and extract the cartridges cases from the chamber.



Figure 21. Front sight (1-32).

1 - threaded portion of sight;
2 - longitudinal groove;
3 - flat edges for key.



Figure 22. Front sight stud (1-31).

1 - threaded hole;
2 - alignment index.

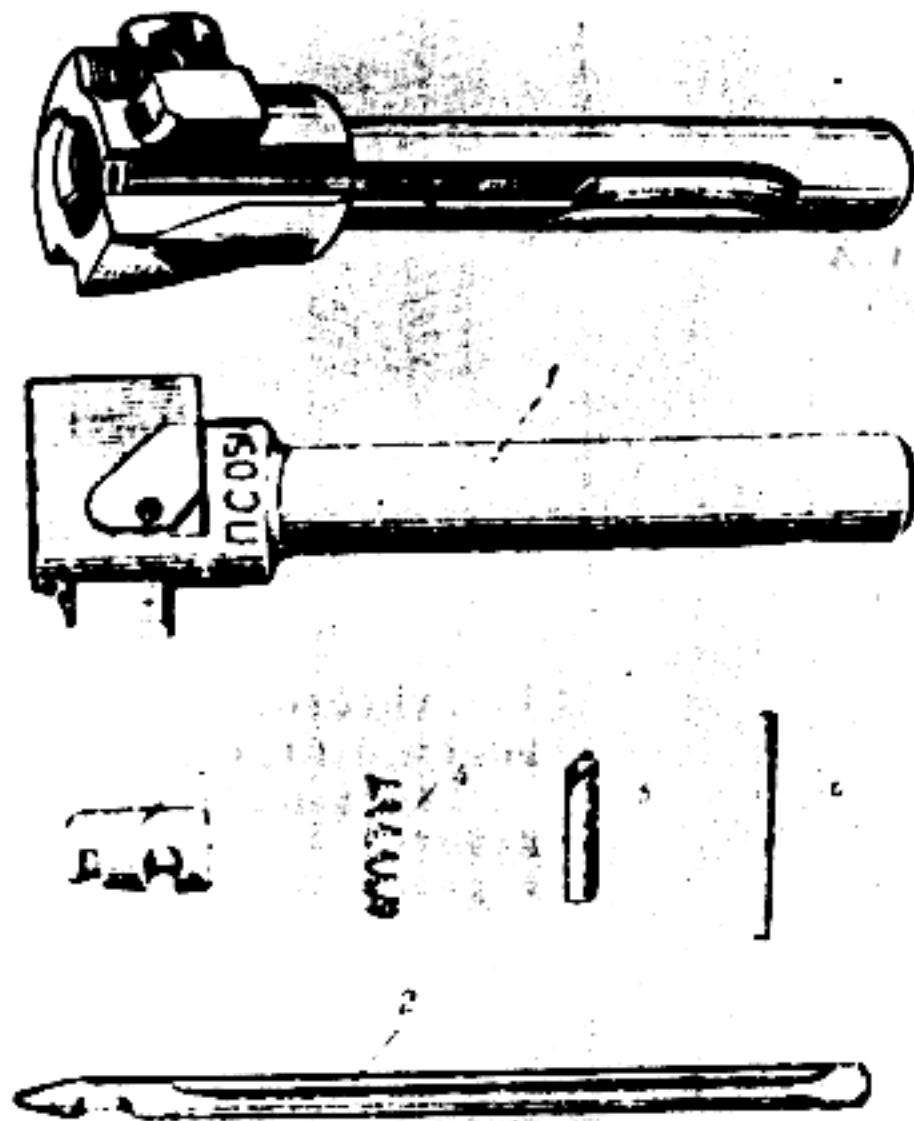

Figure 23. Bolt, assembled and disassembled (assy. 3-2).

1 - bolt body (3-4); 2 - firing pin (3-5);
 3 - extractor (3-6); 4 - extractor spring
 (3-7); 5 - extractor pin (3-10); 6 - re-
 taining pin (3-9).

The bolt consists of a body (1), firing pin (2), extractor (3) with spring (4) and pin (5), and pin (6).

The bolt body (fig. 24) serves to hold all the components of the bolt. The body consists of a bolt head, central cylindrical portion (2), and rear cylindrical portion (3).

The bolt head has a right (4) and left (5) lugs; guide lug (6); feed rib (7), the forward edge of which pushes out the rounds from the magazine feed block into the chamber; recess (8) for the extractor and spring; housing (9) for holding the cartridge case rim.

The bolt lugs engage the receiver lugs to seal the bore. The left lug (5) has a bevel, which together with the screw bevel of the cam (30) (see fig. 10) rotates the bolt a certain amount when the bore is about to be sealed. The lower edge (10) of the right lug together with the receiver cam limits rotation of the bolt to the right when the bore is being sealed.

The bolt is moved and rotated in sealing and opening the bore by means of the leading edge (6) of the bolt, which is guided by the walls of the groove in the operating rod.

The guide lug has a rear flat face (a), screw bevel (b), forward round face (c), and screw bevel (d).

The rear face (a) of the guide lug is guided by the variable groove of the operating rod when the latter is moving forward, thus causing the bolt to move forward until the bore starts to be sealed.

The screw bevel (b) of the guide lug is guided by the screw bevel of the variable groove in the operating rod, thus causing the bolt to rotate when the bore is being sealed.

The screw bevel (d) of the guide lug is guided by the screw bevel of the variable groove in the operating rod, thus causing the bolt to rotate when the bore is being opened.

The forward face (c) of the guide lug is guided by the forward wall of the variable groove in the operating rod when it is moving to the rear, thus causing the bolt to move to the rear after the bore is opened.

The left edge (e) of the guide lug, together with the straight wall of the variable groove in the operating rod, keeps the bolt from rotating to the left when the bore is sealed.

In addition, in the bolt head there is a hole (11) for the extractor pin and a hole (12) for the firing pin retaining pin.

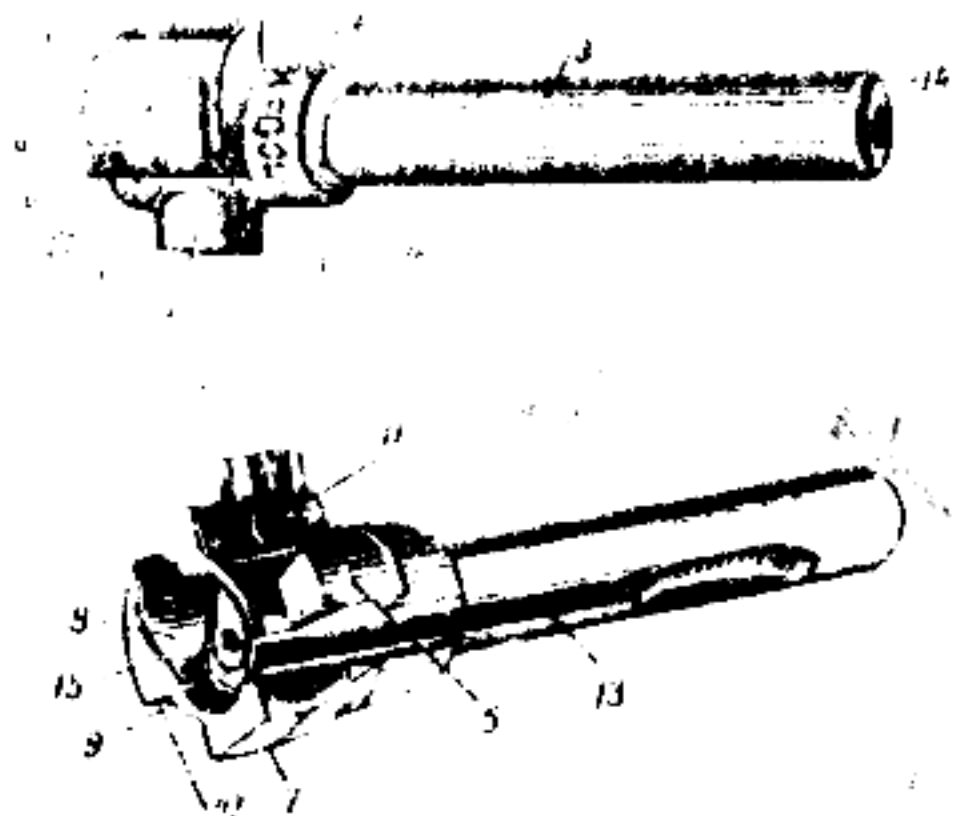

Figure 24. Bolt body (3-4).

1 - bolt head; 2 - central cylindrical portion; 3 - rear cylindrical portion; 4 - right lug; 5 - left lug; 6 - guide lug; 7 - feed lever; 8 - recess for extractor and spring; 9 - face; 10 - lower edge of right lug; 11 - hole for extractor pin; 12 - hole for retaining pin; 13 - longitudinal groove for extractor; 14 - channel for firing pin; 15 - hole for passing tip of firing pin; a - rear flat face of guide lug; b - screw bevel of guide lug; c - forward face of guide lug; d - screw bevel of guide lug; e - left edge.

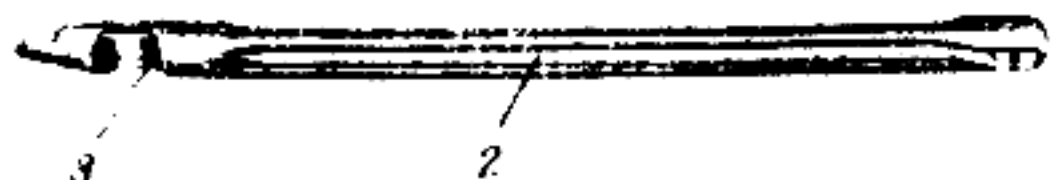

Figure 25. Firing pin (3-5).

1 - tip of firing pin; 2 - longitudinal grooves for decreasing weight of firing pin and decreasing friction between firing pin and bolt body; 3 - notch for retaining

The hole for the extractor pin has a smaller diameter at the bottom than the diameter of the pin, thus forming a circular shoulder in the hole.

In the body there is a longitudinal groove (13) for passing the extractor; in the rear portion, the groove is made wider for passing the extractor when the bolt is rotating as the bore is being sealed or opened.

In the center of the body there is a channel (14) for housing the firing pin. In the forward portion the channel is conical in shape, and the other end terminates in a hole (15) for passing the tip of the firing pin.

The firing pin (fig. 25), together with the hammer, pierces the primer of the round.

The firing pin is divided into the rear and the forward portion. The forward portion terminates in the tip of the firing pin (1); in the rear portion there are three longitudinal grooves (2) for decreasing the weight of the firing pin and for decreasing friction as it moves in the channel in the bolt body.

The firing pin is prevented from falling out of the body by pin (6) (fig. 23), by means of the notch (3) in the firing pin.

The extractor (fig. 26) with spring (2) removes the cartridge case from the chamber and holds it in the bolt housing until it meets the ejector.

The extractor has a flange (1a) for grasping the cartridge case rim, a recess (1b) for extractor spring, and a recess (1c) for extractor pin.

The extractor with spring is installed in the bolt head by means of pin (3). The extractor pin is prevented from falling out of its hole by pin (6) (see fig. 23) and the shoulder in the hole for the pin.

5. OPERATING ROD

The operating rod (fig. 27) actuates the bolt.

To the operating rod are attached rod (1) with piston (2).

Rod (1) is integral with the piston; the rod is connected with the operating rod by means of threads (3) and pin (4), which is installed in hole (5) in the rod and the forward end of the operating rod.

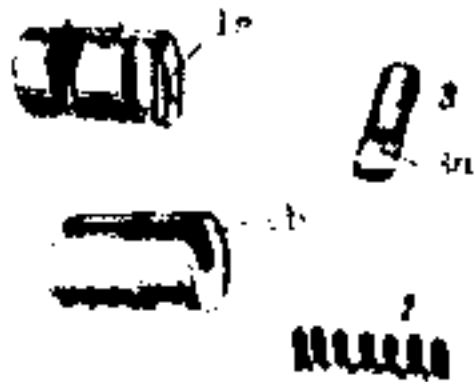

Figure 26. Extractor (3-6) with spring and pin.

1 - extractor (3-6); 1a - flange for grasping cartridge case rim; 1b - recess for extractor spring; 1c - recess for extractor pin; 2 - extractor spring (3-7); 3 - extractor pin (3-10); 3a - notch in extractor pin.

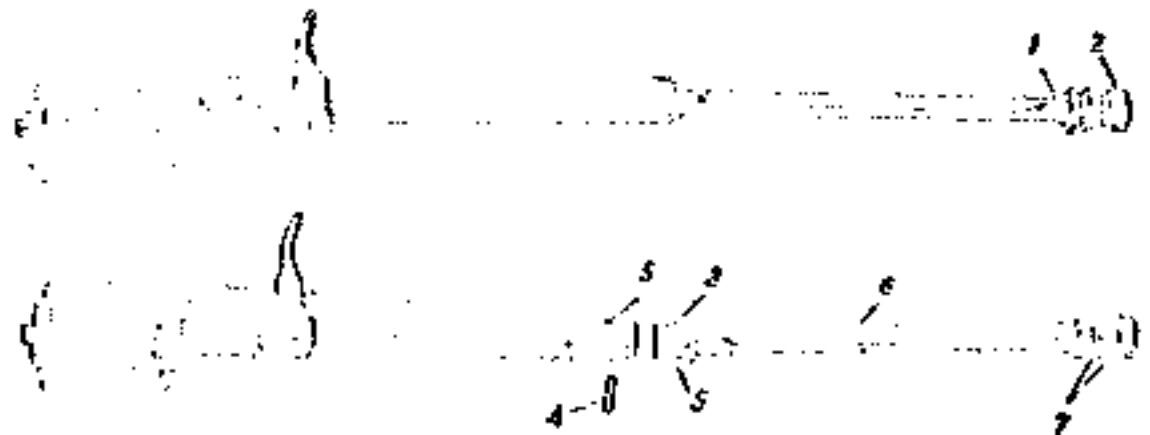

Figure 27. Operating rod, assembled and disassembled.

1 - rod (3-2); 2 - piston; 3 - threads for connection with operating rod; 4 - pin for connection of rod and gas piston rod (3-3); 5 - hole for pin; 6 - grooves; 7 - grooves.

In the rod there are four grooves (6) for decreasing its weight.

Piston (2) receives the pressure of the gases in the gas cylinder and transmits the pressure, through the gas piston rod to the operating rod.

In the piston there are grooves (7) for decreasing the escape of gases between the piston and the walls of the gas cylinder.

On the forward face of the piston there is a sharp rim which scrapes off carbon from the walls of the gas cylinder as the operating rod moves.

The operating rod (fig. 28) has a lug in the rear portion with cylindrical channel (8) in which the rear end of the bolt is installed. In the sides of the lug there are grooves (9) which guide the operating rod in the receiver.

On the right side of the lug there is a lug (10) which disconnects the full automatic sear, and is called the full automatic disconnecter.

On the left side the lug has a notch (11) for passing the ejector, a rear bevel (12) for smooth cocking of the hammer when the operating rod is moving to the rear, and a forward bevel (13) for depressing the cocked hammer as the operating rod is moving forward.

On the right side of the operating rod there is a cocking handle (14).

On the rear face of the operating rod there is a cam (15) for cocking the hammer when the operating rod starts to move to the rear.

In the central portion of the operating rod there is a cam surface (16) on which the bolt guide rides. The bolt is made to move by means of this groove, and also to rotate in opening and closing the breech.

The cam has two screw bevels (a and b) which engage with the corresponding screw bevels of the bolt guide (see fig. 24) in opening and closing the breech.

The forward portion of the cam surface is wider since it contains the bolt guide when the operating rod is in motion in opening and closing the breech. Before the breech is completely sealed, the rear perpendicular wall (c) guides the rear flat face of the bolt guide, as a result of which the bolt moves forward

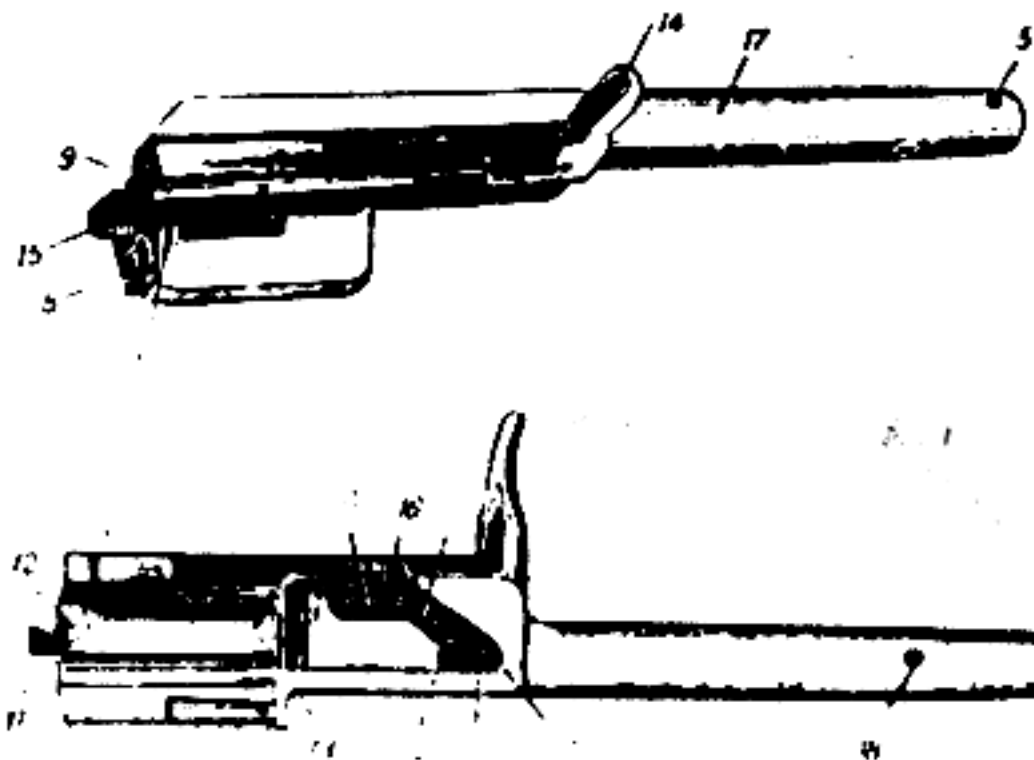

Figure 28. Operating rod (3-1).

A. Right view; B. Bottom view.

5 - hole for pin; 8 - cylindrical channel for rear end of bolt; 9 - right groove; 10 - lug, which is called the automatic trigger disconnect; 11 - notch for ejector; 12 - rear bevel of lug; 13 - upper bevel of lug; 14 - cocking handle; 15 - cam or cocking hammer; 16 - cam surface; 17 - cylindrical portion of operating rod; 18 - hole for releasing air and excess oil; a - screw bevel; b - screw bevel; c - rear perpendicular wall; d - cam surface forward round wall; e - longitudinal wall.

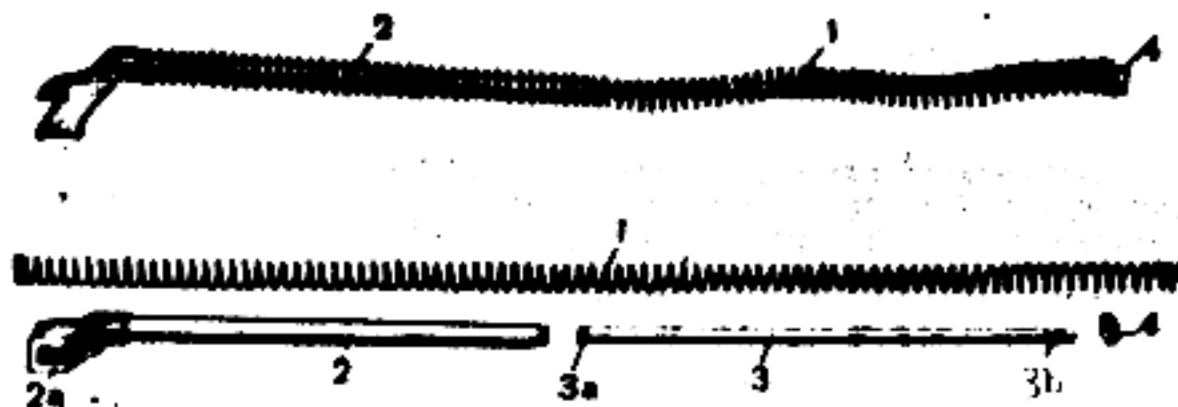

Figure 29. Return mechanism, assembled and disassembled (assy. 4).

1 - return spring (4-3); 2 - guide (4-1); 2a - connecting lug; 3 - guide rod (4-2); 3a - guide rod shoulder; 3b - washer notches; 4 - washer

together with the operating rod, thus excluding the possibility of its rotation before the breech is sealed. After the breech is opened, the cam surface forward round wall (d) guides the forward round face of the bolt guide, thus causing the bolt and the operating rod to move to the rear.

When the breech is closed, the left edge of the bolt guide presses against the left wall (e) of the cam, thus preventing the bolt from rotating to the left.

On the right the cam surface is cut to pass the bolt guide when the bolt is being separated from the operating rod or connected to the rod.

In the cylindrical portion (17) of the operating rod there is a channel which contains the return mechanism; interior threads for receiving the rod; hole (5) for the pin; and hole (18) for releasing air and excess oil when the operating rod is in motion.

6. RETURN MECHANISM

The return mechanism (fig. 29) consists of the return spring (1), guide (2), guide rod (3) and washer (4).

The return spring returns the operating rod and bolt to the extreme forward position after firing.

The guide (2) and guide rod (3) prevent the return spring from bending, and also make assembly and disassembly of the rifle more convenient.

On the inside of the forward portion of the guide there is a shoulder which stops the guide rod, and at the rear end there is a connecting lug (2a) for connecting the return mechanism to the receiver.

The guide rod is provided with a shoulder (3a), which engages with the shoulder of the guide, thus limiting motion of the guide rod; in the forward portion there are washer notches (3b).

The connecting lug (fig. 30) acts as a catch for the receiver cover.

The connecting lug has a shoulder (1) which retains the rear end of the return spring; guide lugs (2) for holding the connecting lug in the receiver grooves; lug (3) for holding the receiver cover; recess (4) for lug (15) (see fig. 28) of the operating rod as it moves to the extreme rear position. In the guide there is a channel (5) for guiding the guide rod.

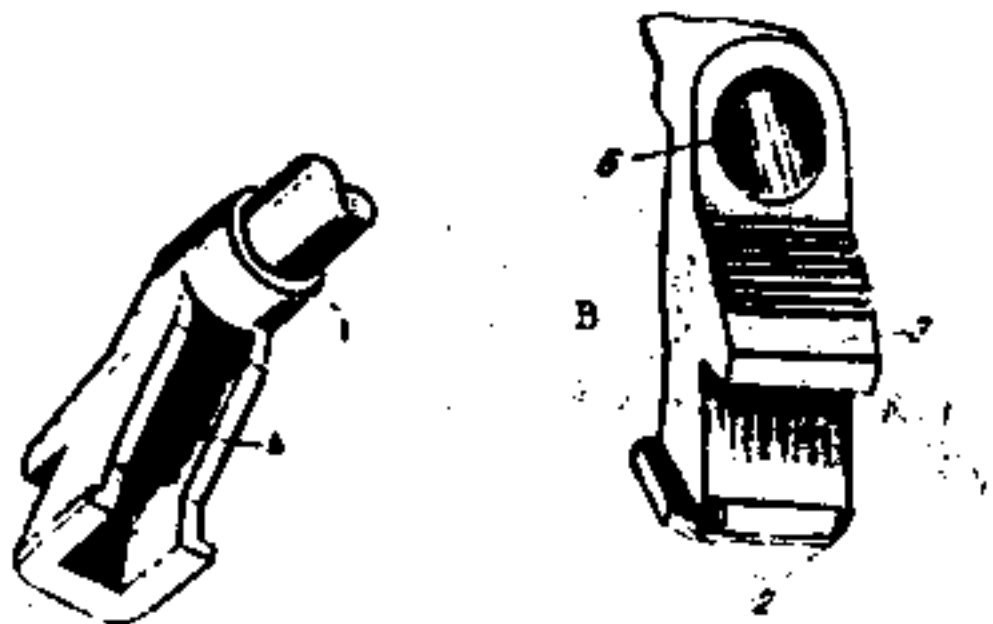

Figure 30. Connecting lug.

A. Front view; B. Rear view.

- 1 - shoulder for stopping return spring;
- 2 - guide lugs for holding receiver lug;
- 3 - lug for holding receiver cover; 4 - recess for operating rod lug; 5 - channel for guide rod.



Figure 31.
Washer (4-4).

- 1 - flange;
- 2 - cut; 3 - recess.

Washer (fig. 31) serves as a stop for the return spring. It has a flange (1) which stops the forward edge of the return spring; cut (2) for mounting the washer on the guide rod; and recess (3) for the forward edge of the guide rod.

When the operating rod moves to the rear, the return spring compresses between the washer and the shoulder on the guide lug.

7. FIRING AND TRIGGER MECHANISM

The firing and trigger mechanism (fig. 32) serves to release the hammer from the semiautomatic sear and, together with the bolt, serves to fire the round. It permits of firing semiautomatic and full automatic fire.

The firing and trigger mechanism is housed inside the receiver and consists of a hammer (1), hammer and trigger spring (2), trigger (3), disconnecter (4), disconnecter spring (5), full automatic sear (6), full automatic sear spring (7), and selector (8) with lever.

The hammer (fig. 33) serves to strike the firing pin; it has a head (1) the flat portions (1a and 1b) of which serve as the cock notch (1a) and disconnecter notch (1b). The head is rounded in the lower portion to obtain smooth action on the sear and on the disconnecter.

In the lower portion of the hammer is the full automatic sear notch (2); tubular base (3) on which the hammer and trigger spring is mounted.

In the central portion there is a connection (4) for the spring.

The hammer is fastened in the receiver by means of a pin which passes through the tubular base.

The hammer and trigger spring (fig. 34) serves to impart energy to the hammer for the purpose of piercing the primer of the round. In addition, it actuates the trigger.

The hammer and trigger spring is made of 3-strand cable. It has a spring loop (1) which grasps the hammer body; two ends (2) with bent ends (2a) which press against the rear shoulders of the trigger. The hammer and trigger spring is mounted on the tubular base of the hammer.

The trigger (fig. 35) serves to actuate the parts of the firing and trigger mechanism. It has a sear (1) which serves as a stop for the hammer, both for semiautomatic and full automatic fire; hole (2) for the pin; bars (3) which are acted on by the ends of the spring; recess (3a) for the base of the disconnecter; and trigger (4).

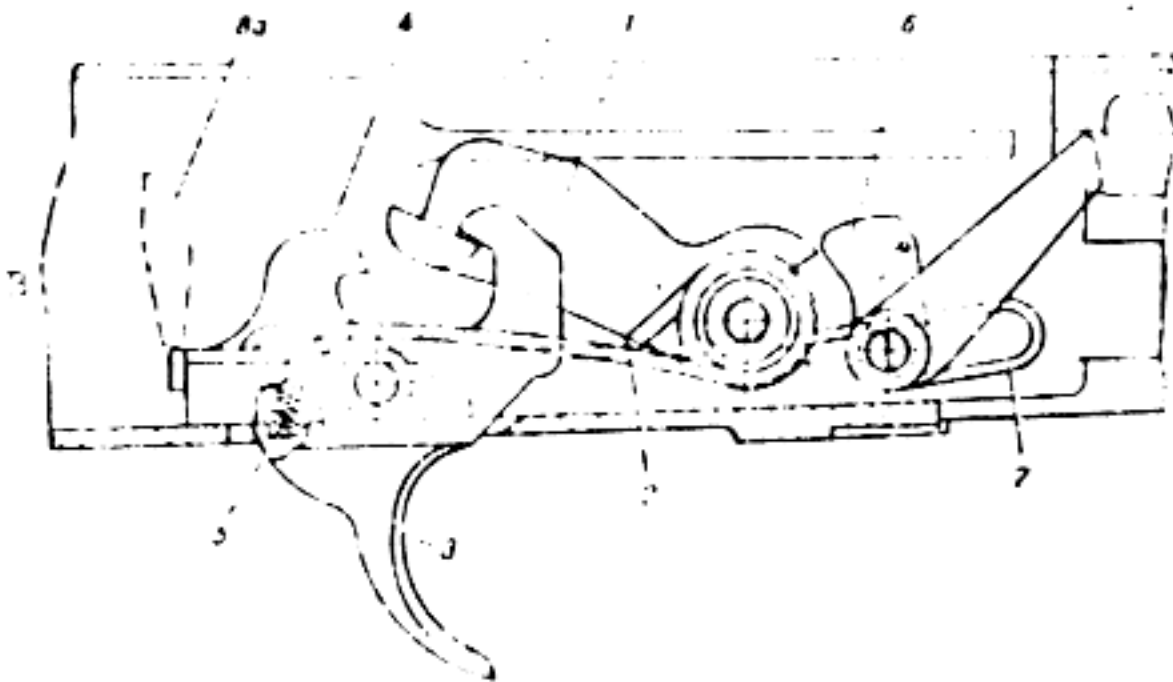
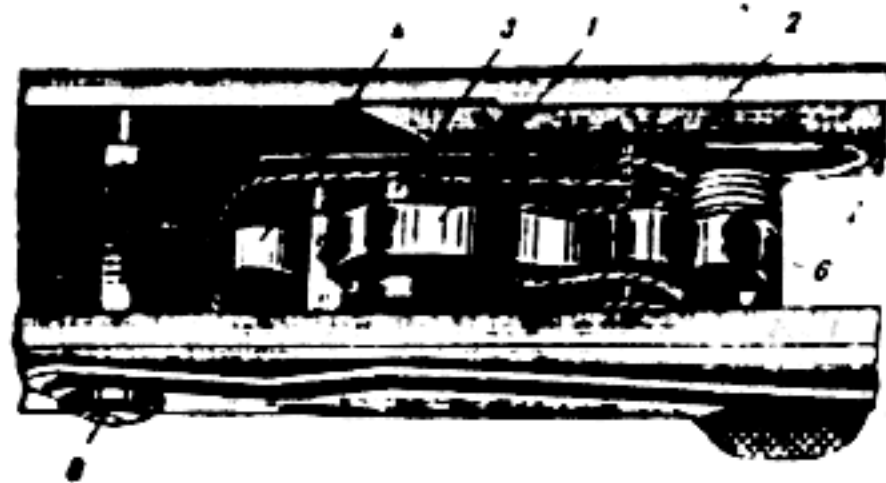

Figure 32. Firing and trigger mechanism.

A. Assembled; B. Sectional view.

1 - hammer (0-2); 2 - hammer and trigger spring (0-3); 3 - trigger (0-8); 4 - disconnector (0-9); 5 - disconnector spring; 6 - full automatic sear; 7 - full automatic spring (0-6); 8 - selector (assy. 1-3); 8a - selector lever.

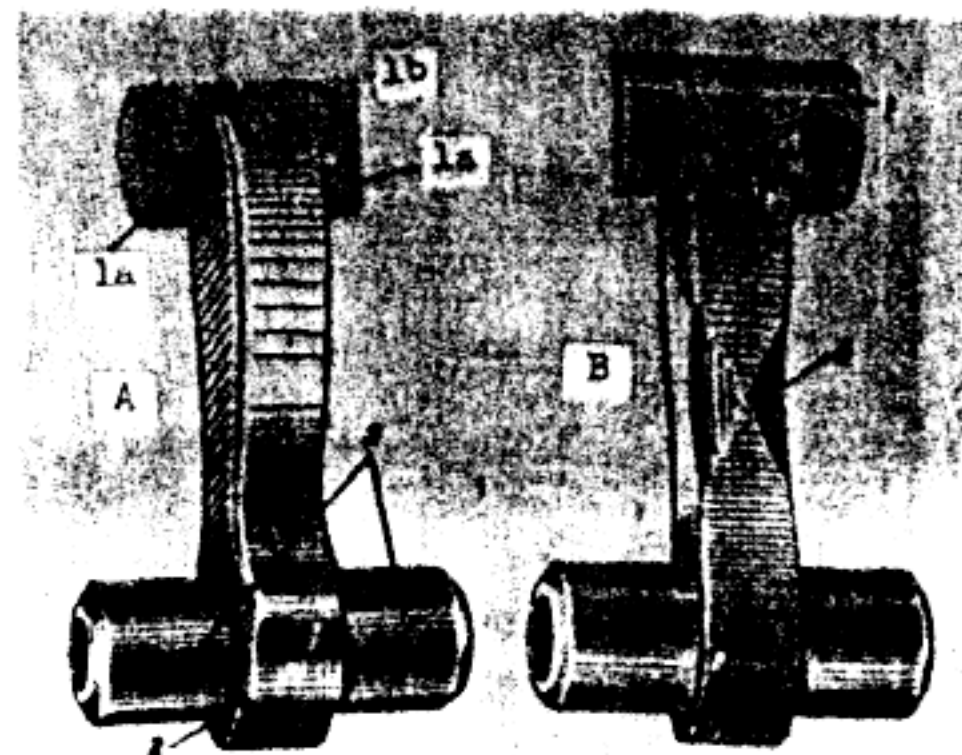

Figure 33. Hammer (0-2).

A. Front view; B. Rear view.

1 - head; 1a - cock notch; 1b - disconnector notch; 2 - full automatic sear notch; 3 - tubular base; 4 - connection for spring.

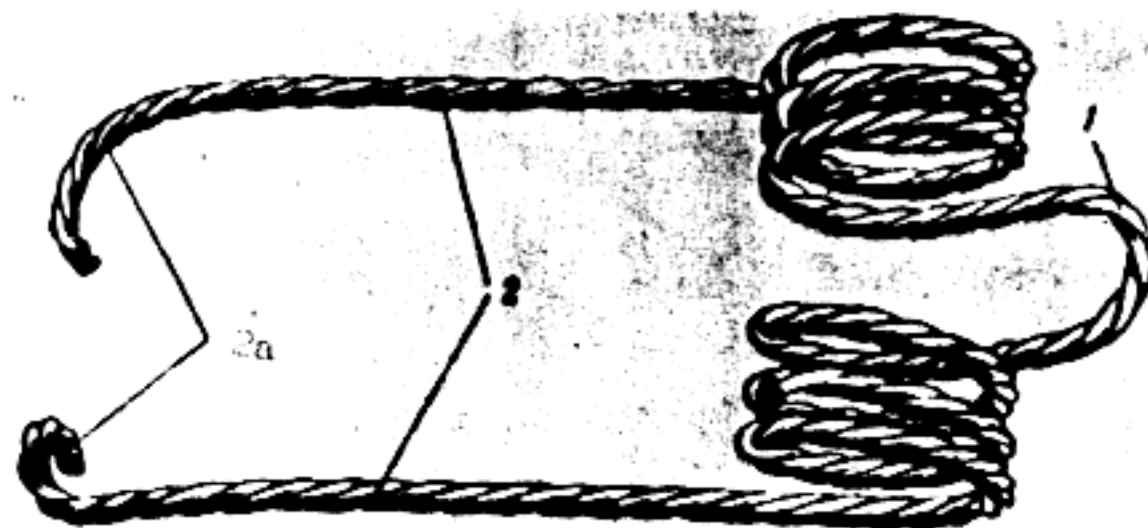

Figure 34. Hammer and trigger spring (0-3).

1 - spring loop; 2 - spring ends; 2a - bent ends.

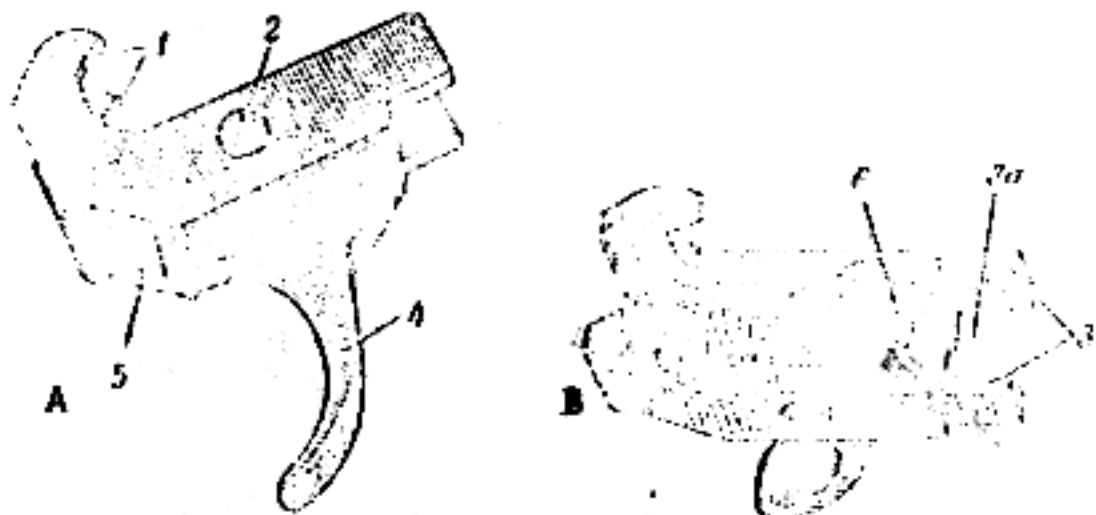

Figure 35. Trigger (0-8).

A. Left view; B. Top view

- 1 - semiautomatic sear; 2 - hole for pin; 3 - bars; 3a - recess for base of disconnecter;
- 4 - trigger; 5 - recess for disconnecter; 6 - recess for disconnecter spring.



Figure 36. Disconnecter (0-9).

- 1 - cam; 2 - lug; 3 - hole for pin; 4 - stop;
- 5 - recess for spring; 6 - disconnecter spring (0-10).

In the trigger there is a recess (5) for the disconnecter spring; in the base of the recess there is a recess (6) for the disconnecter spring. The ends of the hammer and trigger spring serve as the trigger spring. The trigger is installed in the receiver by means of a pin.

The disconnecter (fig. 36) holds the hammer at full cock in semiautomatic fire if the trigger is not released.

It has a cam (1), lug (2), hole (3) for pin, stop (4), the lower surface of which presses against the base of the groove in the trigger and does not permit the sear to rotate to the front, and recess (5) for disconnecter spring (6).

The disconnecter is installed on the same pin as the trigger.

The full automatic sear (fig. 37) serves to hold the hammer at full cock in full automatic fire, and prevents firing when the breech is not completely closed in both semiautomatic and full automatic fire.

The full automatic sear is provided with a lever (1) on the upper end of which acts the full automatic sear disconnecter (see fig. 28) when the operating rod is moving to the extreme forward position; the full automatic sear (2); hole (3) for pin; hole (2a) for connecting the short end of the full automatic sear spring.

The full automatic sear is installed in the receiver on a pin. The full automatic sear spring (4) is mounted on the full automatic sear pin and attached to the full automatic sear by means of the short end (4a) which is inserted into hole (2a); the long end (4b) functions as a stop of the pins of the hammer, trigger and full automatic sear, and is installed in recesses of these pins.

Under the action of its spring, the full automatic sear has a constant tendency to rotate to the rear and retain the hammer on the full automatic sear by means of its sear.

The pins (fig. 38) of the hammer, trigger and full automatic sear are identical.

On the left ends of the pins there are shoulders (1) by means of which they press against the left wall of the receiver; grooves (2) in which the long (stop) end of the full automatic sear spring is located; the latter prevents the pins from falling out of their holes in the receiver.

The selector (fig. 39) is used for changing over the firing and trigger mechanism from semiautomatic

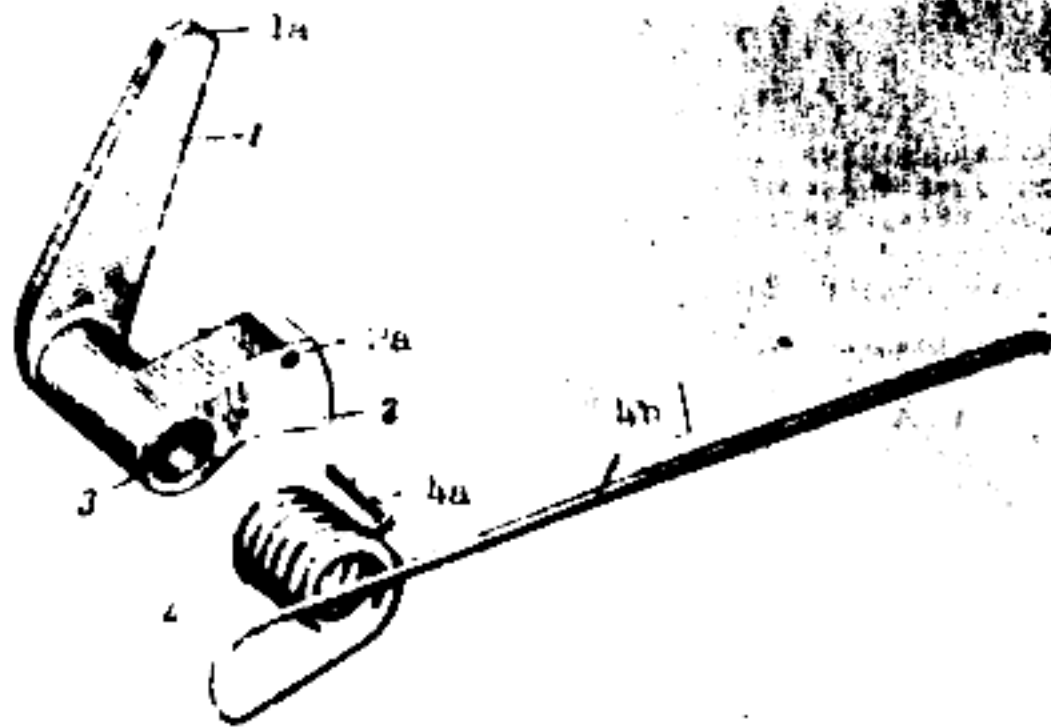

Figure 37. Full automatic sear (0-5).

1 - lever for rotating sear forward; 1a - upper end of sear; 2 - sear; 2a - hole for connecting short end of spring; 3 - hole for pin; 4 - full automatic sear spring (0-6); 4a - short end of spring; 4b - long (stop) end of spring.

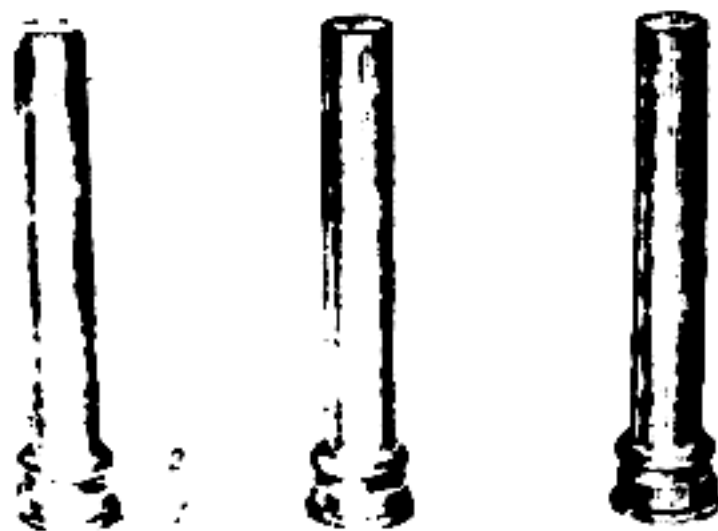

Figure 38. Trigger mechanism pins (0-25).

1 - shoulder; 2 - groove.

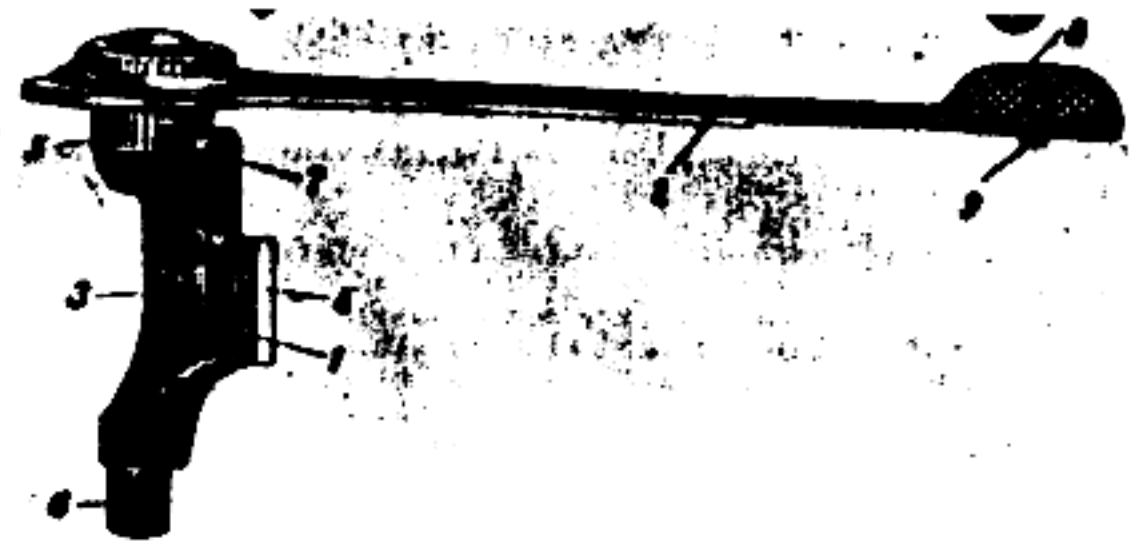

Figure 39. Selector (assy. 1-3).

1 - lever (1-13); 2 - indicator; 3 - recess for passing operating rod; 4 - lever lug; 5 - right pin; 6 - left pin; 7 - lever shoulder; 8 - grip for rotating indicator; 9 - lug.

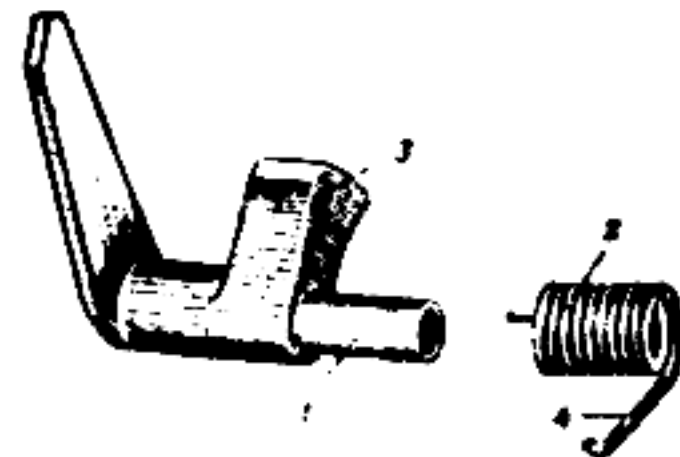

Figure 40. Full automatic sear with stamped receiver.

1 - tubular pin (0-5); 2 - full automatic sear spring (0-6); 3 - hole for short end of full automatic sear spring; 4 - long end of full automatic sear spring.

to full automatic fire, and for setting the safety. It consists of a lever (1) and indicator (2).

In the lever there are a recess (3) for passing the operating rod, a lever lug (4) which acts on the corresponding parts of the firing and trigger mechanism at various positions of the selector, right pin (5) which is placed in and rotates in the round parts of the variable hole in the right wall of the receiver (see fig. 9), left pin (6) which is located in the hole in the left wall of the receiver.

The selector is prevented from falling out of the receiver by shoulder (7) and indicator (2).

The indicator has a grip (8) for rotating the indicator, and a lug (9) for retaining the selector in the desired position.

When the selector is set for the desired type of fire, lug (9) enters the corresponding recess in the right wall of the receiver (see fig. 9).

The selector grip also serves to protect the opening for the cocking handle when the rifle is set on safety.

There are in use rifles with stamped receiver in which the firing and trigger mechanism is not disassembled. The ends of the pins of the hammer, trigger, and full automatic sear of these rifles are staked and held securely in the receiver.

The full automatic sear (fig. 40) of these rifles has a tubular pin (1) on the left end of which is installed the full automatic sear spring (2).

The short end of the full automatic sear spring is held in hole (3) and the long end (4) is held in a notch between the left wall of the receiver and the rear face of the receiver insert (fig. 41).

In rifles with stamped receiver, the selector (fig. 42) has a lever (1) with lug (1a). An indicator (2) is attached to the lever.

8. RECEIVER COVER

The receiver cover (fig. 43) closes the receiver and protects the parts of the rifle from dirt.

In the right wall of the receiver cover there is a step-shaped notch (ignition port) (1) which, together with the

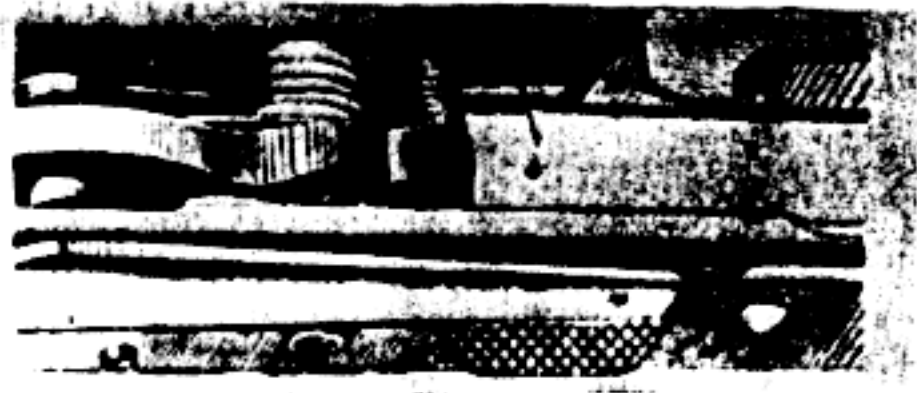

Figure 41. Fastening of long end of full automatic sear spring in rifle with stamped receiver.

4 - long end of full automatic sear spring.

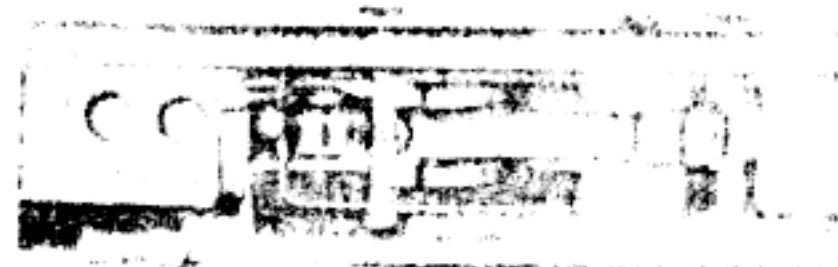

Figure 42. Selector of rifle with stamped receiver.

1 - lever; 1a - lug; 2 - indicator

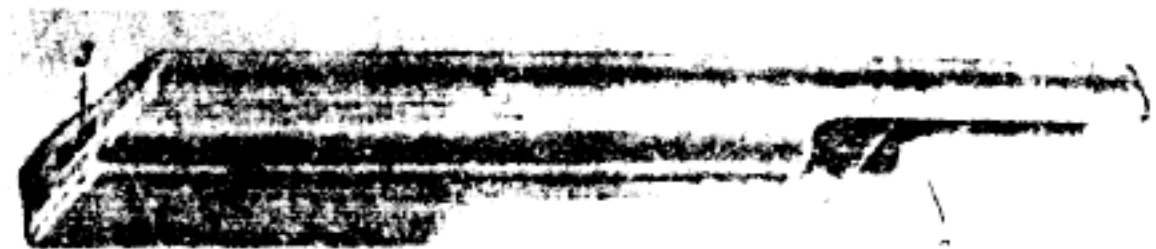

Figure 43. Receiver cover (0-1).

1 - ejection port and port for cocking handle;
2 - notch for receiver lug; 3 - recess for lug on guide rear end (cover latch).

receiver, forms an opening for ejecting cartridge cases, and an opening for the cocking handle; in the left wall there is a notch (2) for the receiver lug; in the rear wall there is a recess (3) for the lug on the rear ends of the guides. The cover is fastened to the receiver by its forward face, which enters a semicircular groove in the base of the rear sight (see fig. 19), and by means of the lug of the guide rear end, which enters an opening in the rear wall of the receiver cover.

9. GAS TUBE AND HAND GUARD

The gas tube (1) (fig. 44) guides the piston and holds the hand guard. In the forward portion of the gas tube, there are eight holes (1b) (four on each side) for passing gases; in the central portion there are corrugations (1a) which decrease friction of the piston as it moves in the gas tube. The rear end of the gas tube has a cylindrical shape, and the forward end of the operating rod moves in it.

On the gas tube are fastened the forward (3) and rear (4) bands of the hand guard with flanges (3a and 4a), which hold the hand guard.

The hand guard (2) protects the hands of the rifleman from burns in prolonged firing and provides more convenience in operating the rifle. In the bottom portion of the hand guard there are four recesses (2a) (two on each side) for air circulation. The hand guard is attached to the gas tube by means of bands (3 and 4).

The gas tube with hand guard is installed on the barrel with its forward end on the gas cylinder and its rear end in notch (6) (see fig. 19) of the rear sight base by means of the gas tube lock.

10. PISTOL GRIP

The pistol grip (fig. 45) provides more convenience in directing the fire. It has a cap (1) for protecting the pistol grip against splitting, recess (2) for the base of the pistol grip, groove (3) for trigger guard, a recess for the screw washer, and a channel on the inside for passing the pistol grip screw.

The pistol grip is attached to its base by means of screw (4) which is threaded into the base. There are also rifles with stamped receiver in use (fig. 46); in these models, the pistol grip consists of two stocks (1 and 2). The stocks are fastened to pistol grip (5) by means of screw (3) with nut (4).

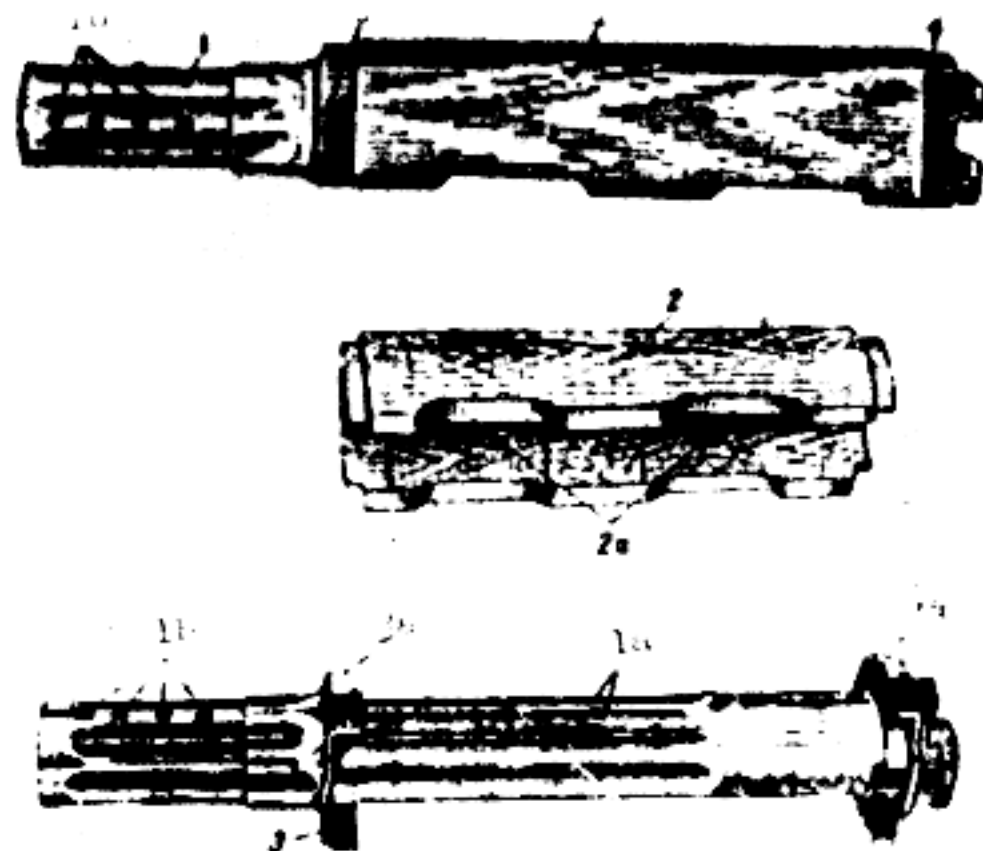

Figure 44. Gas tube with hand guard, assembled and disassembled (assy. 1-12).

1 - gas tube (assy. 1-2); 1a - corrugations; 1b - holes for passing gases; 2 - hand guard (1-40); 2a - recesses; 3 - forward band; 3a - flange; 4 - rear band; 4a - flange.



Figure 45. Pistol grip (assy. 8).

1 - cap for protecting the grip against splitting (8-2); 2 - recess for base of grip; 3 - groove for trigger guard; 4 - screw (0-19).

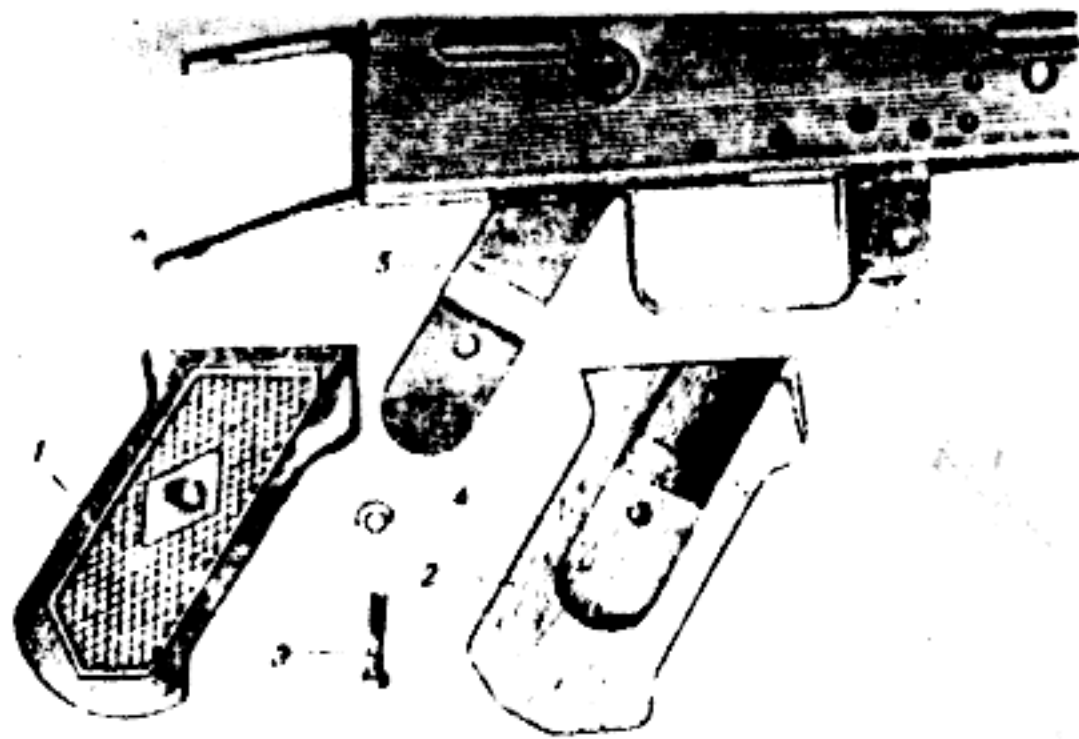

Figure 46. Pistol grip of rifle with stamped receiver.

- 1 - right stock (0-17); 2 - left stock (0-18); 3 - screw (0-19); 4 - nut (0-20); 5 - base of pistol grip.

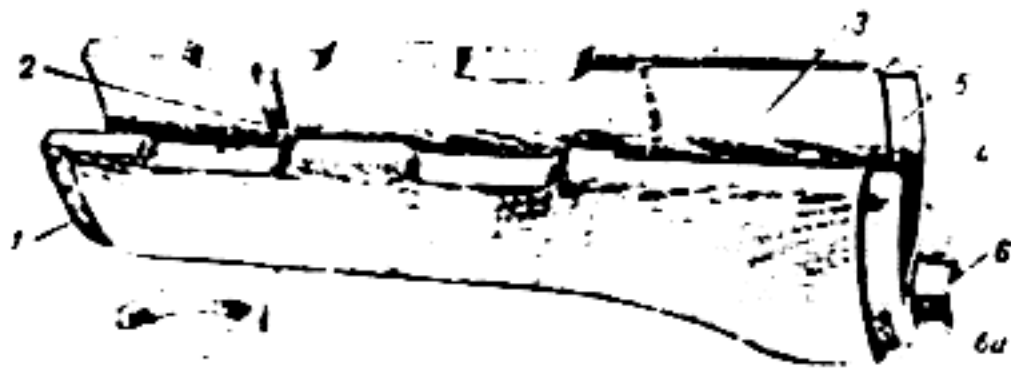

Figure 47. Fore end (assy.6).

- 1 - band shoulder; 2 - notch for clamp; 3 - recess for base of sight; 4 - clamp (6-12); 5 - notch for barrel shoulder; 6 - lug for holding fore end in receiver; 6a - lugs for holding clamp in fore end; 7 - clamp (0-15).

11. FORE END

The fore end (fig. 47) makes handling of the rifle more convenient and protects the hands of the rifleman from burns during intensive firing. It has a shoulder (1) for the band, notch (2) for clamp (7), recess (3) for the rear sight base lug, clamp (4) for protecting the fore end from splitting, notch (5) for the barrel lug, lug (6) for attaching the fore end to the receiver. In the fore end there is a channel for passing the cleaning rod.

The clamp is retained on the fore end by means of two lugs (6a). In the top of the fore end there are four notches (two on each side) for air circulation.

Clamp (7) protects the fore end from warping and sticking to the barrel.

The fore end is attached to the barrel by means of a band which is mounted on the forward end of the fore end and a lug (6) which is placed in a recess below the receiver (see fig. 10).

12. BUTT

The butt (fig. 48) makes handling of the rifle more convenient. It has a clamp (1), a butt plate (2), and swivel (3).

In the butt (fig. 49) there is a recess for the accessories case and case spring (5) which holds the case in the butt and ejects the case when the plate is removed.

The butt is attached to the receiver by means of a clamp and pin.

The clamp (fig. 50) protects the butt from splitting and holds it to the receiver. The clamp has a recess (1) for the forward end of the butt, two lugs (2) with holes for screws, lug (3) with grooves for attaching the butt to the receiver. On the lug there is a groove (4) for the pin which holds the butt to the receiver. The clamp is attached to the butt by means of screws (5).

The butt plate (fig. 51) protects the butt from splitting. It has flanges (1) for grasping the face of the butt, hole (2) through which the accessory case is inserted, and holes (3) for screws (4).

The cover (5) closes the hole in the butt plate. It has a base (6) and spring (9).



Figure 48. Butt (assy. 5).

1 - clamp (5-13); 2 - butt plate (5-2); 3 - swivel (assy. 5-1).



Figure 50. Clamp (5-13).

A. Right view; B - Left view.

1 - recess for forward end of butt; 2 - lugs with holes for screws; 3 - lug for attaching butt; 4 - groove; 5 - screws.

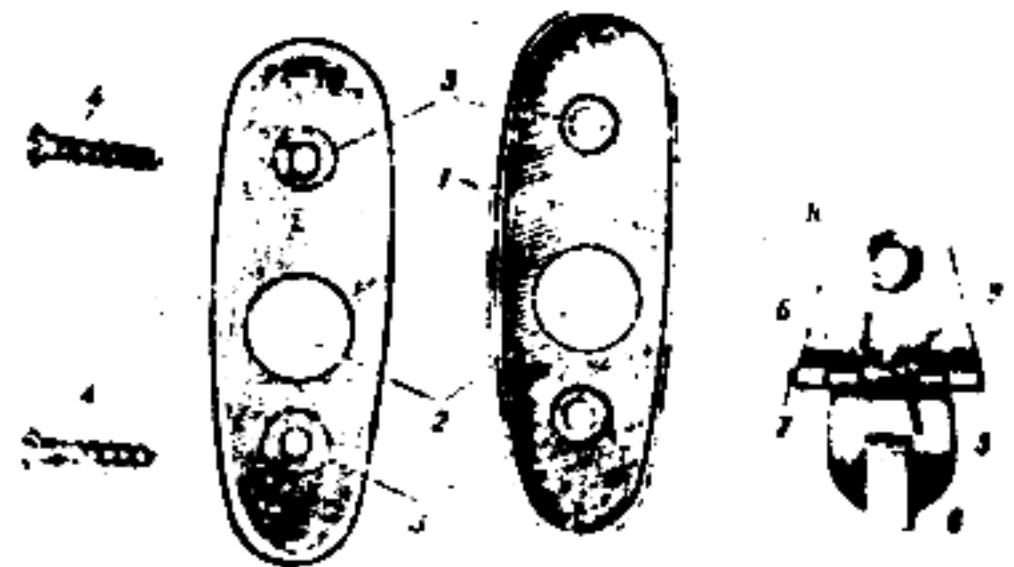

Figure 51. Butt plate (5-2) with cover.

1 - clamp (5-13); 2 - butt plate (5-2); 3 - swivel (assy. 5-1); 4 - recess for case and case spring; 5 - case spring (5-5); 6 - cover base; 7 - butt plate cover pin; 8 - bent portions of cover; 9 - screws.

1 - flanges; 2 - hole for passing case with accessories; 3 - holes for screws; 4 - screws; 5 - cover (5-8); 6 - cover base (5-9); 7 - cover pin (5-11); 8 - bend portion of cover; 9 - cover spring (5-10); 10 - hole for screw.



Figure 52. Swivel (assy. 5-1).

1 - ring (5-7); 2 - base (5-6); 3 - screws; 4 - holes for screws.

The cover has a bent portion (8) for compressing the accessory case into the recess when the cover is removed.

The cover and spring are attached to the cover base by means of pin (7). The cover base is attached to the butt plate by means of screw (4) which passes through the upper hole in the butt plate and hole (10) in the base.

The swivel (fig. 52) attaches the sling to the butt. It consists of a ring (1) and base (2). The base has two holes (4) for screws (3) which hold the swivel to the butt.

In automatic rifles with stamped receiver, the butt is attached directly to the receiver rear plate (see fig. 16) by means of two screws.

The folding metal stock (fig. 53) consists of two bars (1) and a shoulder rest (2).

On the forward ends of the bars there are lugs (1a) for the stock pin, and on the rear end there are lugs (1b) for the pins of the shoulder rest. In the rear ends of the bars there are locks (3) with springs (4) which retain the shoulder rest in the service position.

In the right bar there is a notch (1d) for passing the selector indicator grip when the stock is folded.

In the lug of the left bar there are a hole (1e) and semicircular notch (1f) for the stock catch.

The shoulder rest is attached to the bars by means of pins (5), the ends of which are flattened.

The stock catch (fig. 54) holds the stock in the service and folded positions.

The stock pin (1) holds the stock to the receiver. It has a rim (1a) which functions as a stop for the pin, oval-shaped hole (1b) for the catch pin, thread (1d) for the nut, and hole (1e) for the nut pin. The catch (2) has two lugs (2a) which enter the holes in the left wall of the receiver and lock the left bar of the stock in the service and folded position. The catch is mounted on the pin and fastened by means of a pin, which is inserted in hole (2b) and passes through the oval-shaped hole (1b).

Catch plunger (3) has a hole (3a) for the pin, by means of which it is connected to the catch.

The swivel (4) is attached on the stock pin. Nut (5) attaches the stock bars to the receiver. It has a hole (5a)

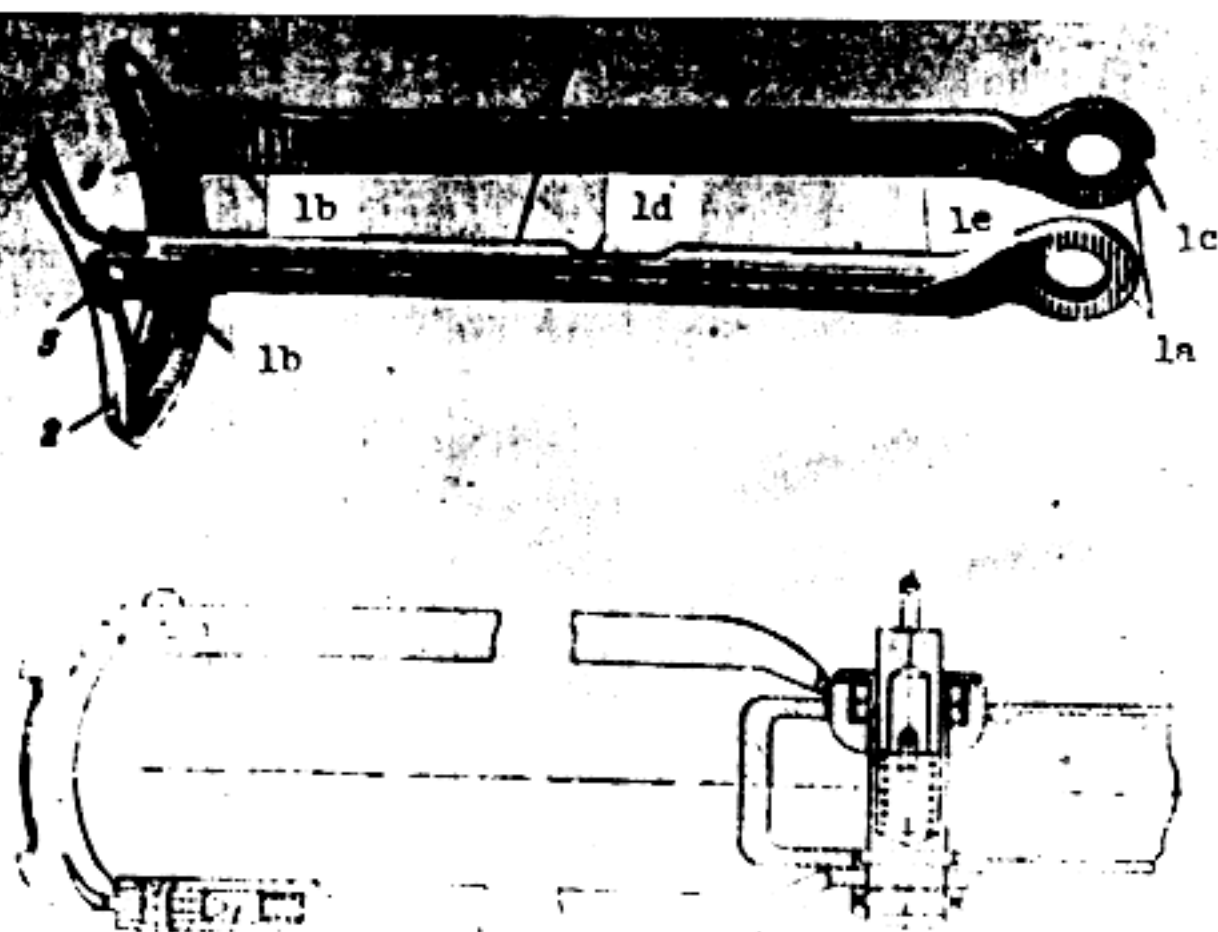

Figure 53. Folding metal stock. (General view and cross section)

1 - bars (1-50; 1-51); 1a - lugs for stock pin; 1b - lugs for shoulder rest; 1d - notch for passing selector indicator grip; 1e - hole for stock catch; 1f - notch for butt catch; 2 - shoulder rest (1-52); 3 - shoulder rest lock (1-53); 4 - shoulder rest lock spring (1-54); 5 - shoulder rest pins (1-55).

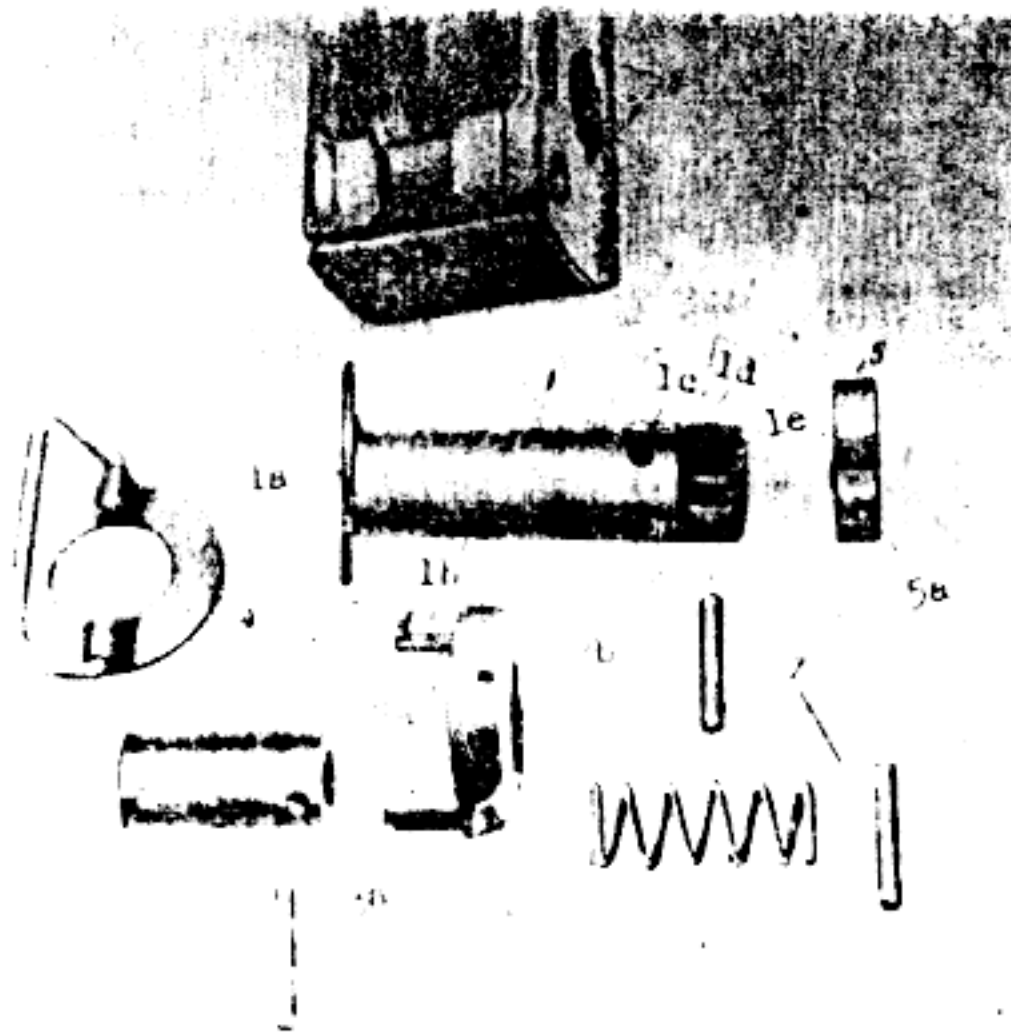

Figure 54. Stock catch.

1 - stock pin (1-56); 1a - rim; 1b - oval-shaped hole for catch pin; 1c - hole for stop pin; 1d - thread for nut; 1e - hole for pin; 2 - catch (1-58); 2a - catch lugs for locking left bar; 2b - hole for fastening catch on pin by means of set pin; 3 - catch plunger (1-57); 3a - hole for pin; 4 - swivel (assy. 1-10); 5 - nut for attaching stock bars to receiver (1-60); 5a - hole for pin; 6 - notch for stop pin; 7 - pins (1-6-1); 8 - catch spring.

for the pin. The stock pin is prevented from rotating in the receiver when the catch is open by means of a stock pin, the ends of which enter notches (6) in the right wall of the receiver when the stock is folded.

Catch spring (8) is located inside the stock pin and continually acts on the catch plunger, and by means of the latter, on the catch.

NOTE: In automatic rifles with stamped receiver of an earlier manufacture, the stock pin is flattened on the right and cannot be removed from the receiver.

13. MAGAZINE

The magazine (fig. 55) contains and feeds the rounds. It consists of a body (1), follower (2), follower spring (3), base plate (4) and base plate retainer (5).

The body serves to connect all the parts of the magazine and for holding thirty rounds.

The upper portion of the body acts as a feeding mechanism, and has flanges for retaining each round before it is fed into the chamber. Between the flanges there is a hole for passing the feeder arm, which pushes out each round from the feed mechanism as the bolt moves forward and sends the round into the chamber.

To the top of the magazine body are welded two side plates (1a), stop (1b), and bracket (1c) with catch (1d). The side plates serve to reinforce the upper portion of the magazine body and to position the magazine in the receiver properly.

Catch (1b) holds the forward portion of the magazine to the receiver; when the magazine is attached, the catch enters notch (27) of the receiver (see fig. 10). Section (1e) of the magazine body, together with lugs (28) of the receiver (see fig. 10), limit the upward movement of the magazine, and groove (1f) serves to pass the lower portion of the receiver cam.

Stock (1b) holds the rear portion of the magazine to the receiver; when the magazine is being attached to the receiver, the magazine catch is engaged by stop (1b), thus preventing the magazine from falling out.

In the lower portion of the magazine body there are flanges for attaching the cover plate. On the rear wall there is a hole through which the last round of a fully loaded magazine can be seen.

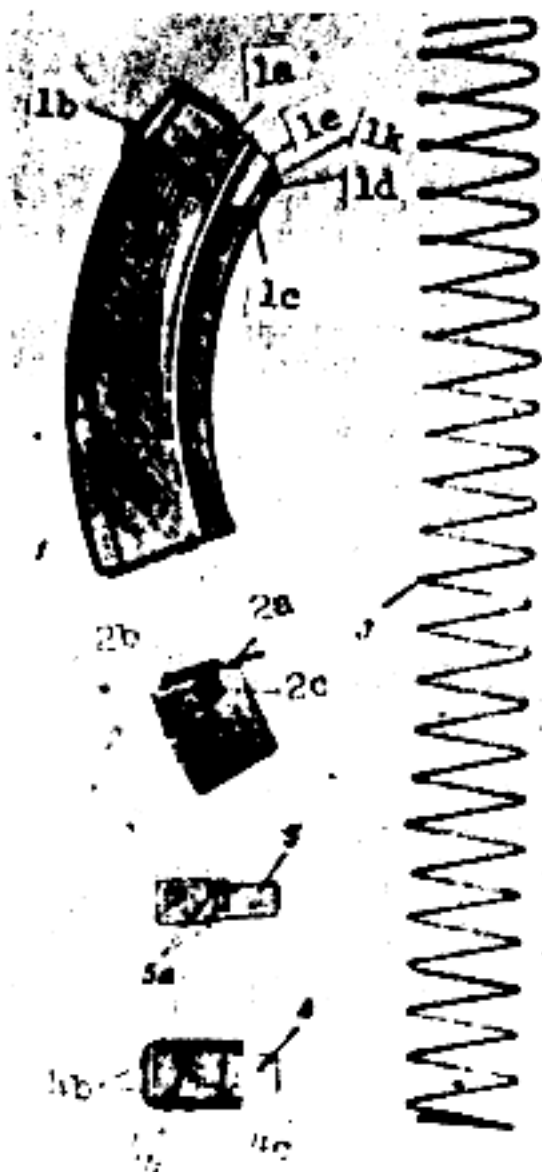

Figure 55. Magazine
(assy. 7)

1 - body (assy. 7-1);
 1a - magazine side
 plates (7-1; 7-2); 1b
 - stop; 1e - bracket
 (7-6); 1d - catch; 1e
 - section; 1f - groove;
 2 - follower (assy.
 7-2); 2a - feed surface;
 2b-lug; 2c-lug for attaching
 spring; 3 - follower
 spring (7-9); 4 -
 magazine base plate
 (7-11); 4a - plate
 flanges; 4b - lugs; 4c
 - hole for stop lug; 5
 - base plate retainer
 (7-1); 5a - catches.

The follower (2) transmits the force of the spring to the cartridges, and, together with the feed mechanism of the magazine, locates each round properly before it is fed into the chamber. It has side plates for guiding the follower, feed surface (2a), on which the round is located, and lug (2b) which locates the rounds in the magazine in a staggered double column. On the right plate, the follower has a lug (2c) for holding the follower spring.

The follower spring serves to feed the rounds into the feed mechanism by means of acting on the follower.

The magazine cover plate seals the magazine. It has flanges (4a) for connection with the magazine body, two lugs (4b) for limiting the motion of the cover plate when the magazine is being assembled, and hole (4c) for passing the base plate retainer lug.

The base plate retainer has a stop lug in the lower section for holding the cover on the body and two catches (5a) for connection with the follower spring.

14. SPARE PARTS AND ACCESSORIES

Each automatic rifle is issued with spare parts and accessories. Sets of spare parts and accessories for units are divided into individual and unit (repair) sets. The individual set includes the accessories (fig. 56) required for the automatic rifle in all conditions of service.

The accessories are designed for assembly and disassembly, cleaning and lubrication, preparation of the rifle for firing, and eliminating stoppages in fire.

The individual set of accessories includes the following items:

Cleaning rod (1) for cleaning and lubricating the bore, gas tube, interior channel of the operating rod, and for assembly and disassembly of the return mechanism. It has a head (1a) with a notch and hole, and threads (1b) for attaching the jag and wire brush (3). The cleaning rod is attached to the rifle underneath the barrel.

Jag (2) for cleaning and lubrication of the bore, gas tube, gas cylinder and channel in operating rod; it consists of a rod with threads for attaching to the cleaning rod, and a rod with notch.

Wire brush (3) for lubricating the bore; it has a rod with threaded channel for connection with the cleaning

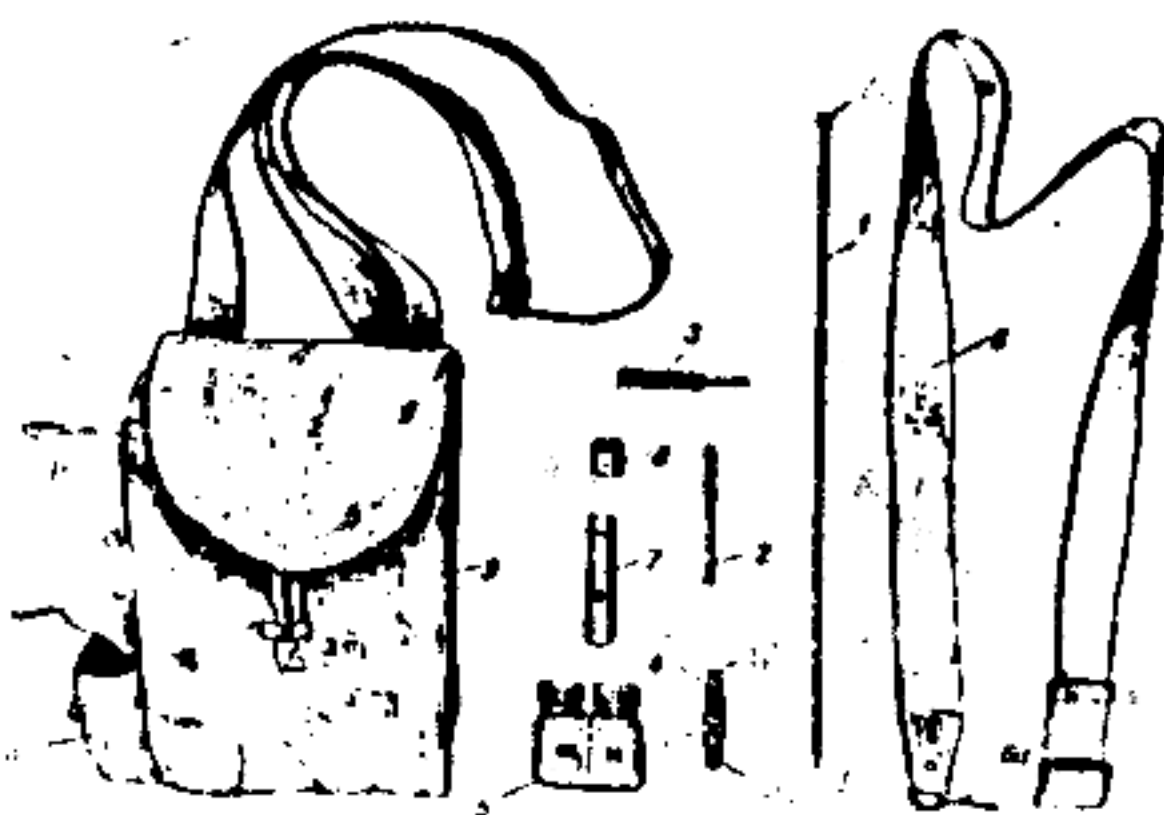

Figure 56. Accessories.

- 1 - cleaning rod (0-24); 1a - cleaning rod head;
 1b - threads; 2 - jag; 3 - wire brush; 4 -
 combination tool (assy. 3); 4a - screw driver;
 4b - key for front sight; 4c - key for jag;
 5 - oil can; 6 - sling (assy. 5); 6a - snap
 (assy. 6); 7 - case (1); 8 - cap (assy. 2);
 9 - bag for magazines; 9a - pocket for oil can;
 9b - pocket for case.

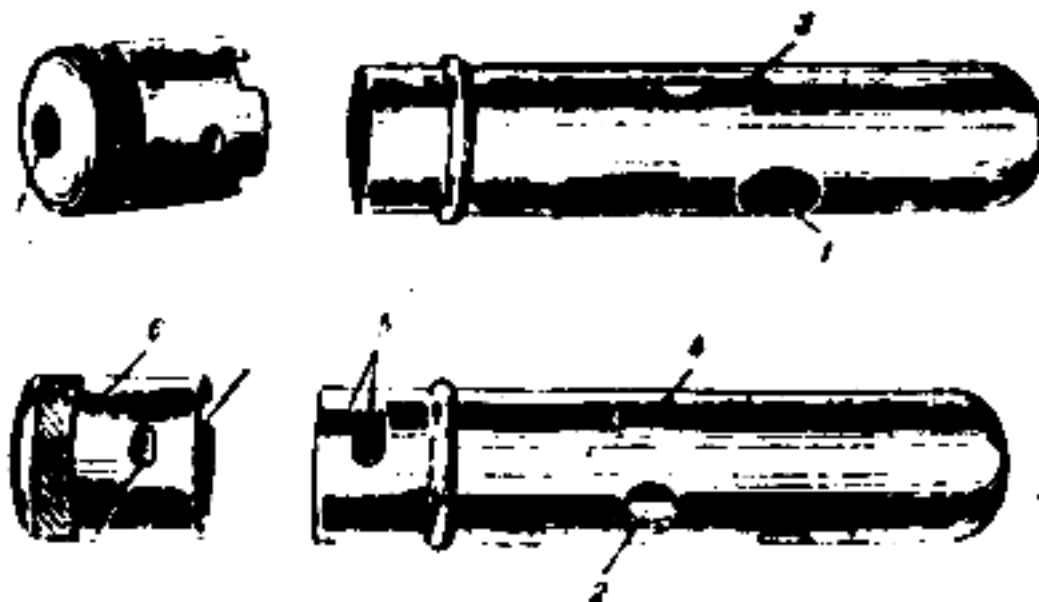

Figure 57. Accessories case.

- 1 - large hole; 2 - small hole; 3 - long
 slot; 4 - short slot; 5 - notches; 6 - cap;
 6a - lugs; 6b - notches for lock; 6c - hole
 for cleaning rod

rod, and a wire rod on which there are bristles for applying lubricant.

Combination tool (4) with knock-out rod. The screw-driver (4a) is used to tighten the screws in the butt, butt plate and sling swivel. The key at the end (4b) is used to screw and unscrew the front sight when zeroing the weapon. The key in the side (4c) is used to attach the jag to the cleaning rod. The knock-out rod is used in disassembly and assembly of the rifle and magazine.

Double can (5). Caustic solution is stored in the compartment marked Shch, and rifle oil in the compartment marked N*. The can is carried in a pocket in the magazine bag.

Sling (6). This is a shoulder sling used only for carrying the rifle. One end is provided with a hook which is attached to the upper swivel on the rifle.

The jag, wire brush and combination tool are stored in the accessories case (7), which is provided with an end cap (8).

Six magazines and a bag (9) with space for five magazines are issued with each rifle. The bag has two side pockets, one (9a) for the double can and one (9b) for the accessories case (which must be carried in this pocket when the rifle in use has a folding metal butt).

The accessories case (fig. 57) serves both as a case for the jag, wire brush and combination tool, and as a handle for the combination tool and cleaning rod. The cleaning rod is attached to the case by passing the rod through the small round hole (2) until the head of the rod fits into the large round hole (1). The combination tool is attached similarly, using the two oval holes (3 and 4).

The cap is held in place by notches (5) in the end of the case.

With rifles with wooden butt, the accessories case is carried in the recess in the butt; with rifles with folding metal butt, the case is carried in the side pocket on the magazine bag.

The cap is fastened to the case by fitting the two lugs (6a) into the notches (5) in the end of the case.

When cleaning the bore, the accessories case cap is used as a cover plate for the muzzle. The cap is attached to the barrel bushing by introducing the two lugs (6a) into the circular groove in the bushing. The cap is held in this

*Shch is Cyrillic Ш, and latin N appears as Cyrillic H.

position by the barrel bushing lock, which fits into one of the four notches (6b) in the rim of the cap. The cleaning rod is inserted into the bore through the hole (6c) in the center of the cap.

CHAPTER 2

FUNCTIONING OF AUTOMATIC RIFLE

15. POSITION OF PARTS BEFORE LOADING

The rifle is set on safety. An empty magazine (8) (fig. 58) is in place in the rifle. (In combat, a fully loaded magazine will be carried in the rifle.)

The magazine catch (9) holds the magazine in the receiver. If the magazine is loaded, the top round presses against the bottom of the operating rod.

The operating rod (4) and bolt (2) are held in forward position by the return spring (5), which also holds the gas piston (6) in the gas cylinder (7). The return spring is in its position of least compression.

The bolt (2) is rotated to the right, with its locking lugs engaging the receiver locking lugs.

The gripping flange of the extractor is pressed against the center of the bolt head by the extractor spring.

The ejector head is located in the wide rear portion of the groove in the bolt.

The full automatic disconnecter holds the full automatic sear (10) rotated forward and out of engagement with the automatic sear notch in the hammer.

The hammer cock notch is disengaged, and the hammer spring (11) presses the hammer (1) against the rear face of the bolt.

The firing pin (3) is in forward position, with its tip protruding out of the bolt head.

The selector is in the extreme top position, obstructing the passage of the cocking handle. The selector lever (14) (fig. 59) is rotated forward. This places the selector lever lug directly over the rear end of the disconnecter and the right trigger bar, preventing both the disconnecter and the trigger from rotating. Since the trigger cannot rotate, the hammer cock notch cannot engage the semiautomatic sear; thus, the hammer prevents the operating rod from moving to the rear.

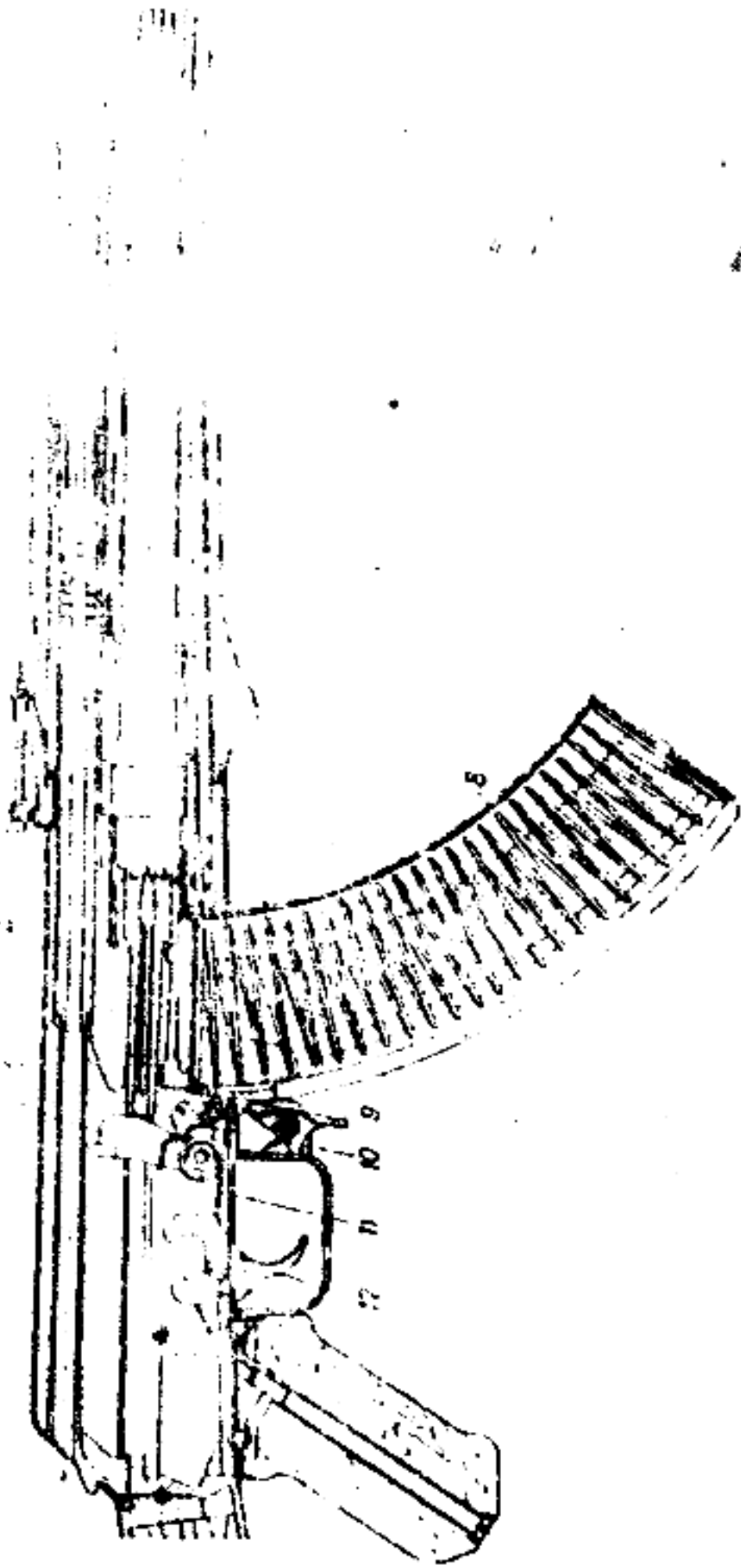

Figure 58. Position of parts before loading (vertical section).

1 - hammer; 2 - bolt; 3 - firing pin; 4 - operating rod; 5 - return spring;
 6 - piston; 7 - gas cylinder; 8 - magazine; 9 - magazine catch; 10 - full
 automatic sear; 11 - hammer and trigger spring; 12 - trigger.



Figure 59. Trigger mechanism set on safety.

1 - hammer; 1a - disconnecter notch; 1b - hammer cock notch; 1c - full automatic sear notch; 10 - full automatic sear; 10a - full automatic sear cock notch; 10b - upper end of full automatic sear; 11 - hammer and trigger spring; 12 - trigger; 14 - selector lever; 15 - disconnecter; 16 - full automatic disconnecter.

The hammer and trigger spring holds the trigger in forward position, with the sear raised.

16. FUNCTIONING OF PARTS DURING LOADING

The rifle is loaded as follows:

1. Insert a loaded magazine into the receiver. (This step is omitted if the magazine carried in the receiver is loaded.)

2. Set the selector by rotating it downward until the indicator is opposite the desired notation on the receiver.

3. Pull the cocking handle as far as possible to the rear and release it.

As the magazine is inserted, the magazine stop rotates the magazine catch backwards; when the magazine is fully inserted, the magazine catch spring rotates the catch forward again, and the catch engages the stop.

When the selector is set for full automatic fire (fig. 60), the passage for the cocking handle is cleared. At the same time, the selector lever lug (14) moves to the rear far enough to release the rear end of the trigger while still remaining directly above the rear end of the disconnecter (15). Thus, while the trigger is free to rotate, the selector lever lug still prevents the disconnecter from rotating. When the selector is set for semiautomatic fire, the selector lever moves all the way to the rear, releasing both the trigger and the disconnecter (15). Thus the disconnecter is free to rotate with the semiautomatic sear when the trigger (12) is pressed.*

As the cocking handle is pulled to the rear, the operating rod, which is integral with the handle, moves to the rear. The return spring is compressed. The upper end (10b) of the full automatic sear is released by the full automatic disconnecter (16); making it possible for the full automatic sear spring to rotate the full automatic sear. The opening bevel in the irregular groove in the operating rod acts on the bolt

* The claws of the trigger which engage the lugs of the hammer are considered to be the semiautomatic sear.

guide lug bevel, while the lug on the rear face of the operating rod acts on the hammer; these actions begin to rotate the bolt to the left and the hammer to the rear, tensing the hammer and trigger spring.

When the operating rod reaches the extreme rear position, the bolt rotates, disengaging the bolt locking lugs from the receiver locking lugs and placing the longitudinal groove in the bolt in position for the passage of the ejector. At the same time, the bolt guide lug enters the wide portion of the irregular groove in the operating rod; as a result of this, the forward curved wall of the groove, acting on the bolt guide lug, moves the bolt to the rear.

The hammer continues to be propelled to the rear, first by the lug on the rear of the operating rod and then by the large lug forming the bottom of the operating rod. As the hammer rotates to the rear, the head of the hammer depresses the semiautomatic sear; and since the pressure on the trigger remains constant, the semiautomatic sear engages the hammer cock notch as soon as the head of the hammer has passed the sear (position of trigger mechanism as in A, fig. 60). When the hammer has reached the extreme rear position, the full automatic sear notch is located opposite the cock notch on the full automatic sear; at this point the full automatic sear spring rotates the full automatic sear to the rear, engaging the full automatic sear cock notch (10a) with the full automatic sear notch (1c) in the hammer (position of trigger mechanism as in B, fig. 60). Simultaneously, the upper end of the full automatic sear rises and obstructs the full automatic disconnecter.

As soon as the bolt feed lever passes the rear wall of the magazine feed mechanism, the follower spring raises the rounds in the magazine, pushing the top round into position in front of the bolt. After this, the head of the ejector moves out of the groove in the bolt.

The rearward movement of the operating rod and bolt is arrested by the rear wall of the receiver. At this point, the return spring is at its greatest tension.

As the cocking handle is released, the return spring begins to move the operating rod forward. The perpendicular wall of the wide portion of the irregular groove in the operating rod acts on the rear surface of the bolt guide lug, thrusting the bolt forward.

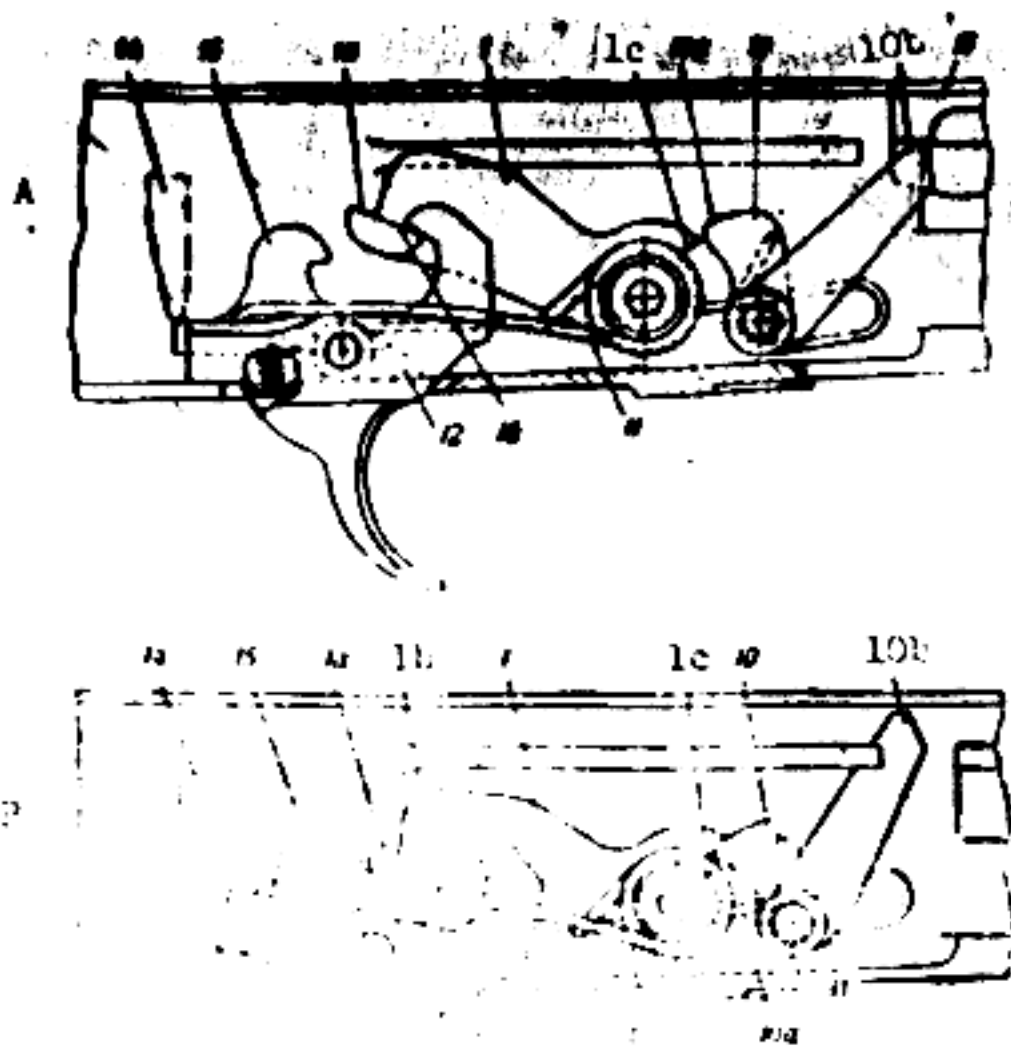

Figure 60. Trigger mechanism in position for full automatic fire.

A. Trigger released; B. Triggered pressed.

- 1 - hammer; 1a - disconnecter notch; 1b - cock notch; 1c - full automatic sear notch;
- 10 - full automatic sear; 10a - full automatic sear cock notch; 10b - upper end of full automatic sear;
- 11 - hammer and trigger spring; 12 - trigger; 14 - selector lever;
- 15 - disconnecter; 16 - full automatic disconnecter.

As the operating rod moves forward, the lower rounded portion of the rod depresses the hammer slightly. The bolt feed lever extracts the top round from under the magazine flange. The ejector enters the groove in the bolt. The round is directed into the chamber by the guides in the receiver and in the rear face of the chamber.

As the bolt approaches the barrel, the screw bevel on the left locking lug runs over the receiver cam surface screw bevel, rotating the bolt to the right and disengaging the bolt guide lug from the irregular groove in the operating rod. The ejector grip engages the groove behind the rim of the cartridge case, and the base of the case positions itself in the bolt face.

The firing pin (3) (fig. 63) moves to the rear, in which position the rear end of the pin protrudes from the rear of the bolt.

When the operating rod reaches the extreme forward position, the irregular groove closing bevel acts on the bolt guide lug bevel, rotating the bolt further to the right and engaging the bolt locking lugs with the receiver locking lugs. The bore is now sealed.

After the bore is sealed, the operating rod continues to move forward. The full automatic disconnecter rotates the upper end of the full automatic sear forward, disengaging the full automatic sear cock notch (10a) (fig. 60) from the full automatic sear notch in the hammer. The hammer rotates forward, engaging its semiautomatic sear notch (1a) (fig. 61) with the semiautomatic sear. This is accompanied by an audible click.

With the parts in this position, the automatic rifle is ready to be fired (see fig. 63).

17. FUNCTIONING OF PARTS DURING SEMIAUTOMATIC FIRE

To fire a single round from the rifle, set the selector for semiautomatic fire by rotating the indicator as far downward as possible, and press the trigger with the index finger of the right hand.

When the trigger is pressed, the semiautomatic sear and disconnecter rotate. The rear end of the sear (i.e., trigger) raises the ends of the trigger and hammer spring. As the trigger rotates, the semiautomatic sear releases the hammer cock notch.

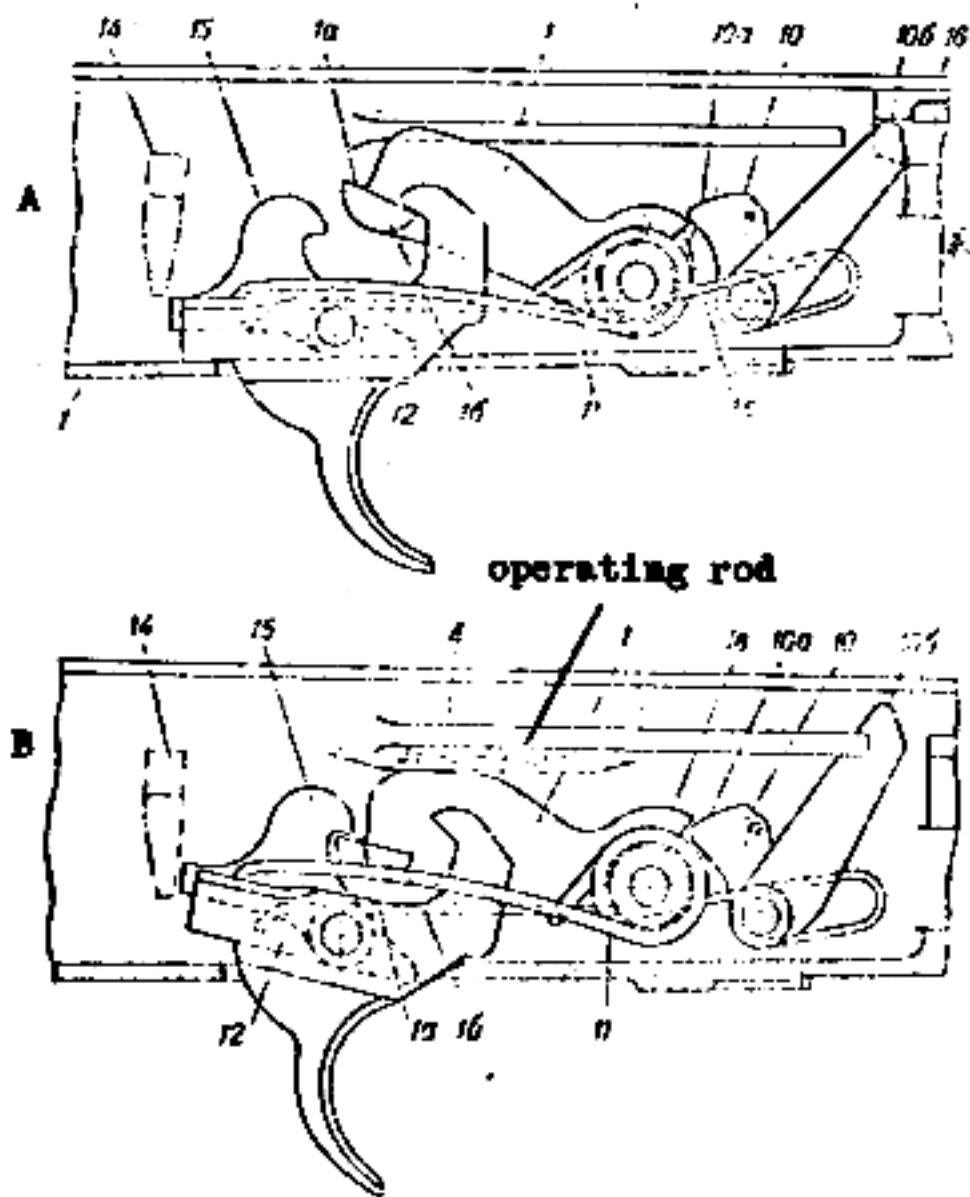

Figure 61. Trigger mechanism in position for semiautomatic fire.

A. Trigger released; B. Trigger pressed.

1 - hammer; 1a - disconnecter notch; 1b - cock notch; 1c - full automatic sear notch; 4 - operating rod lug; 10 - full automatic sear; 10a - full automatic sear cock notch; 10b - upper end of full automatic sear; 11 - hammer and trigger spring; 12 - trigger; 14 - selector lever; 15 - disconnecter; 16 - full automatic disconnecter.

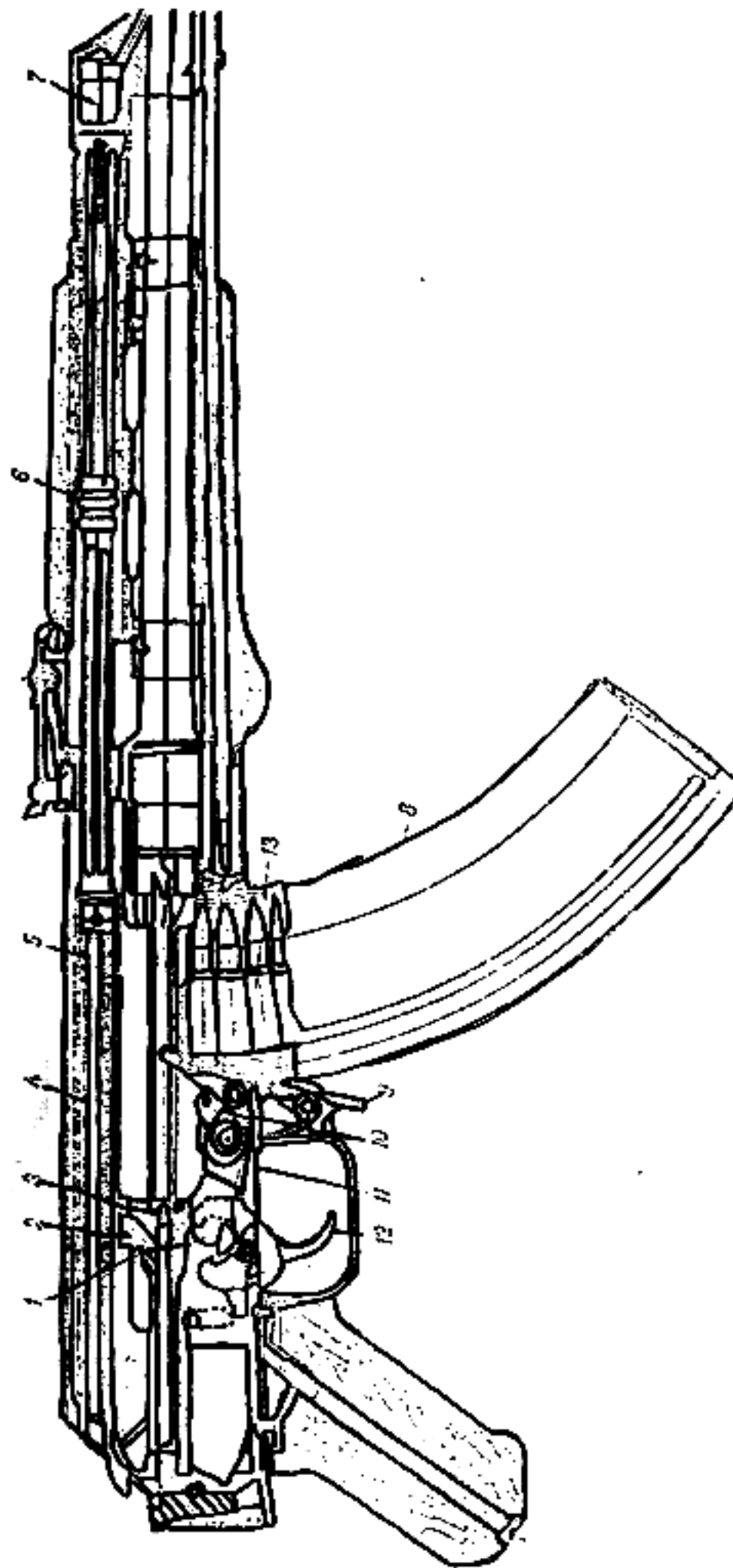

Figure 62. Position of parts with operating rod in extreme rear position.

1 - hammer; 2 - bolt; 3 - firing pin; 4 - operating rod; 5 - return spring; 6 - gas piston; 7 - gas cylinder; 8 - magazine; 9 - magazine catch; 10 - full automatic sear; 11 - trigger and hammer spring; 12 - trigger; 13 - rounds.

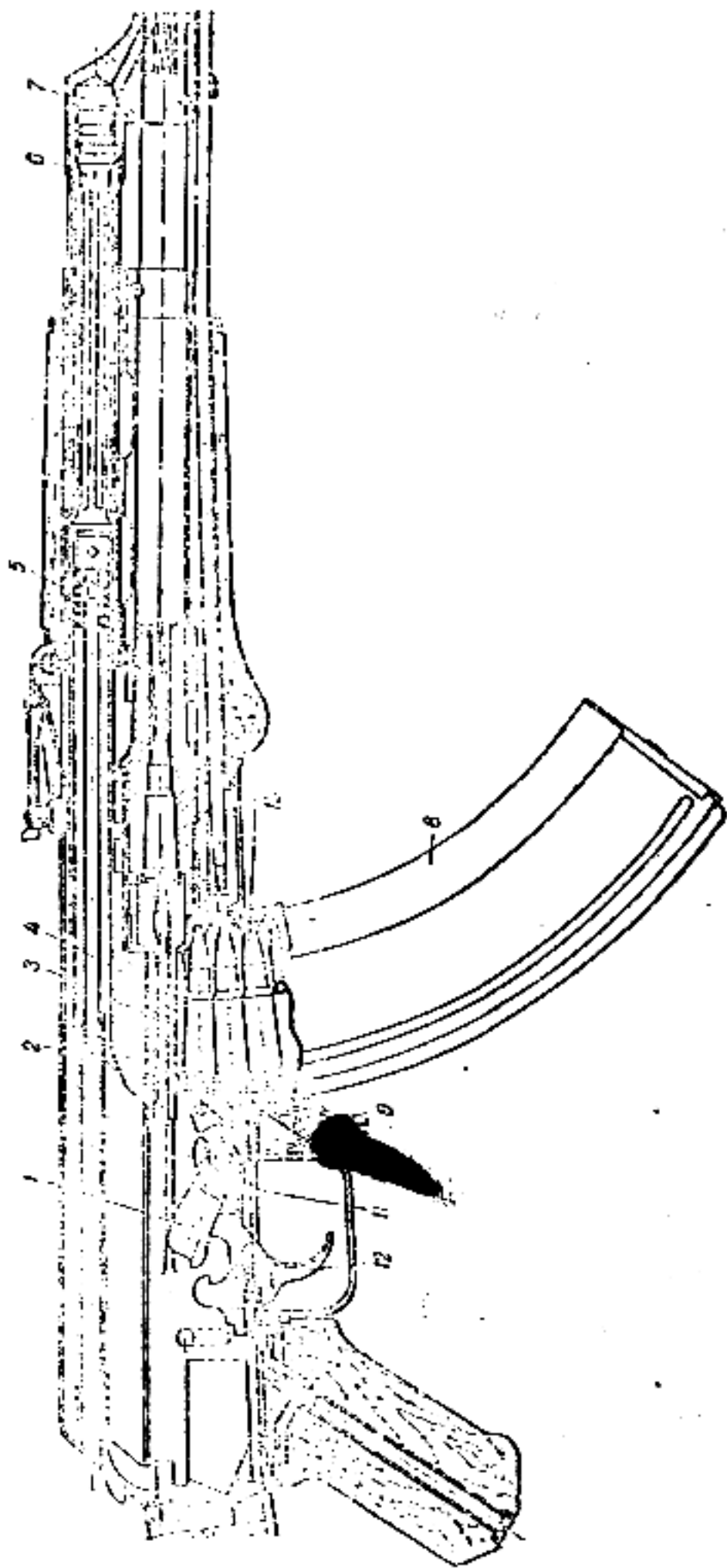

Figure 63. Position of parts after loading and before firing.

1 - hammer; 2 - bolt; 3 - firing pin; 4 - operating rod; 5 - return spring; 6 - gas piston; 7 - gas cylinder; 8 - magazine; 9 - magazine catch; 10 - full automatic sear; 11 - trigger and hammer spring; 12 - trigger; 13 - rounds.

The trigger and hammer spring rotates the hammer forward. The hammer strikes the rear end of the firing pin, thrusting it forward forcibly until the point of the pin strikes the primer, igniting the primer charge. The flash from the primer charge is transmitted to the propellant charge through ports in the base of the cartridge case.

The powder gases force the bullet to cut itself into the rifling and to move through the bore. After the bullet has passed the gas port in the barrel, powder gases enter the gas cylinder (7) (fig. 63) and force the gas piston (6) and operating rod to move to the rear.

As the operating rod moves to the rear, the return spring is tensed. The opening bevel in the operating rod irregular groove acts on the bolt guide lug, rotating the bolt to the left and opening the breech.

After the breech is open, the operating rod and bolt move to the rear together. The operating rod rotates the hammer to the rear, tensing the hammer and trigger spring. As the hammer rotates, it rotates the disconnecter. When the head of the hammer has passed the notch in the disconnecter, the disconnecter spring forces the disconnecter to engage the disconnecter notch in the hammer. This holds the hammer at full cock.

The full automatic sear spring rotates the full automatic sear into engagement with the full automatic sear notch in the hammer. The full automatic sear, however, does not hold the hammer in the cocked position, since the disconnecter (15, fig. 61) is already performing this function. As the full automatic sear rotates, the upper end of the sear rises to obstruct the passage of the full automatic disconnecter.

As the bolt moves to the rear, the extractor pulls the cartridge case out of the chamber. When the case strikes the ejector, it is ejected from the receiver.

The top round in the magazine is forced upward by the follower until it is arrested by the magazine flange.

The rearward movement of the operating rod and bolt is arrested by the rear wall of the receiver. Forward movement of these parts is effected by the energy of the compressed return spring.

As the operating rod moves forward, the bolt feed lever extracts the top round from the magazine and pushes it into the chamber.

As the bolt approaches the barrel, the first stage in the rotation of the bolt to the right takes place. At the same time, the extractor engages the groove behind the rim of the cartridge case. As the operating rod moves to the extreme forward position, it produces the final rotation of the bolt to the right, sealing the bore.

After the bore is sealed, but while the operating rod is still 3-6 mm from the extreme forward position, the full automatic disconnecter (which is integral with the operating rod) strikes the upper end of the full automatic sear and rotates the sear forward. This moves the full automatic sear away from the hammer so that the hammer will not be prevented from rotating.

The next round is fired by releasing the trigger and then pressing it again.

When the trigger is released, the hammer and trigger spring rotates the disconnecter and semiautomatic sear to the rear, disengaging the disconnecter from the disconnecter notch in the hammer. The trigger and hammer spring (11) (fig. 61) rotates the hammer (1) until the hammer cock notch (1b) engages the semiautomatic sear. This is accompanied by an audible click.

When the trigger is again pressed, the semiautomatic sear releases the hammer cock notch. The hammer once again strikes the firing pin, and the entire operating cycle of the automatic mechanism is repeated.

18. FUNCTIONING OF PARTS DURING FULL AUTOMATIC FIRE

To fire the rifle fully automatically, set the selector on full automatic fire by rotating the indicator until it is opposite the letters AV on the receiver, and press the trigger with index finger of the right hand.

When the trigger is pressed, it rotates on the trigger pin. The disconnecter (15) (fig. 60) does not engage the disconnecter notch in the hammer, since the disconnecter is prevented from rotating by the selector lever (14).

As the trigger rotates, the semiautomatic sear releases the hammer cock notch. The hammer and trigger spring rotates the hammer, which strikes the firing pin forcibly. The round is fired. The powder gases act on the gas piston, thrusting the operating rod to the rear, opening the breech, extracting and ejecting the cartridge case, and cocking the hammer.

The full automatic sear engages the full automatic sear notch in the hammer, holding the hammer at full cock.

The top round in the magazine is raised by the follower.

As the operating rod and bolt are moved forward by the return spring, the round is inserted into the chamber and the breech is sealed.

When the operating rod is 3-6 mm from the extreme forward position, the full automatic disconnecter strikes the upper end of the full automatic sear and rotates the sear, releasing the hammer. The hammer strikes the firing pin, firing the next round. The entire operating cycle of the automatic mechanism is repeated.

The rifle will continue firing until the last round in the magazine is used or until the firer releases the pressure on the trigger. In the first case, the operating rod and bolt will remain in the forward position and the hammer will not be cocked. In the second case, a round will be inserted into the chamber and the hammer will remain cocked; the rifle will cease firing but will remain loaded.

19. FUNCTIONING OF PARTS DURING UNLOADING

The rifle is unloaded as follows:

1. Withdraw the magazine.
2. Pull the cocking handle as far to the rear as possible and release it.
3. Release the hammer by pressing the trigger.
4. Set the safety.

As the cocking handle is pulled to the rear, the extractor pulls the cartridge case out of the chamber and holds it against the bolt head. When the base of the cartridge case strikes the ejector, it is ejected from the receiver.

When the cocking handle is released, the return spring returns the operating rod and bolt to the forward position.

When the trigger is pressed, the semiautomatic sear releases the hammer cock notch; the hammer and trigger spring rotates the hammer, which strikes the bolt.

When the safety is set, the parts are in the same positions occupied before loading (see Section 15).

CHAPTER 3

DISASSEMBLY AND ASSEMBLY

20. GENERAL INSTRUCTIONS

The rifle may be disassembled for cleaning, lubrication, inspection, and replacement or repair of defective parts.

The following instructions should be observed during disassembly and assembly:

1. The rifle should be disassembled on a table or bench. In the field, a clean covering should be spread on the ground.
2. The parts should be laid out in order of disassembly.
3. Force should not be used to remove or disassemble parts, as this may result in damage to the parts.
4. Only accessories in good condition should be used.
5. When tightening or loosening screws, the screwdriver is to be held firmly in the hand, and the screwdriver blade is to be held in the screw notch at an angle.
6. The automatic rifle is to be field stripped for cleaning and lubrication after firing, exercises, and detail, and also for inspection.
7. The automatic rifle is to be detail stripped for removing storage or factory lubrication, for changing to a new lubrication, for replacing damaged parts and for repair, whenever it is extremely dirty or moist.
8. Disassembly, assembly, cleaning and lubrication are performed under the supervision of an officer.
9. Before the rifle is disassembled, make sure there is no round in the chamber.

21. FIELD STRIPPING

1. Remove the magazine from the rifle. Holding the rifle by the fore end with the left hand, rotate the rifle a certain

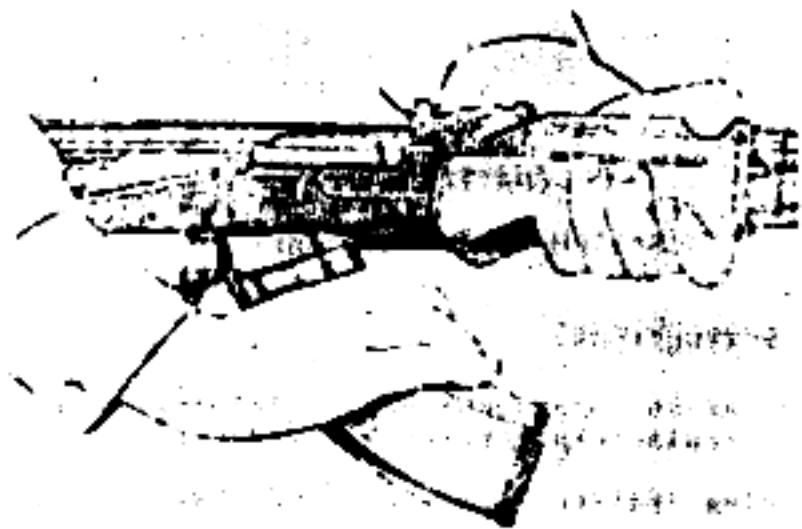

Figure 64. Removing the magazine from the rifle.

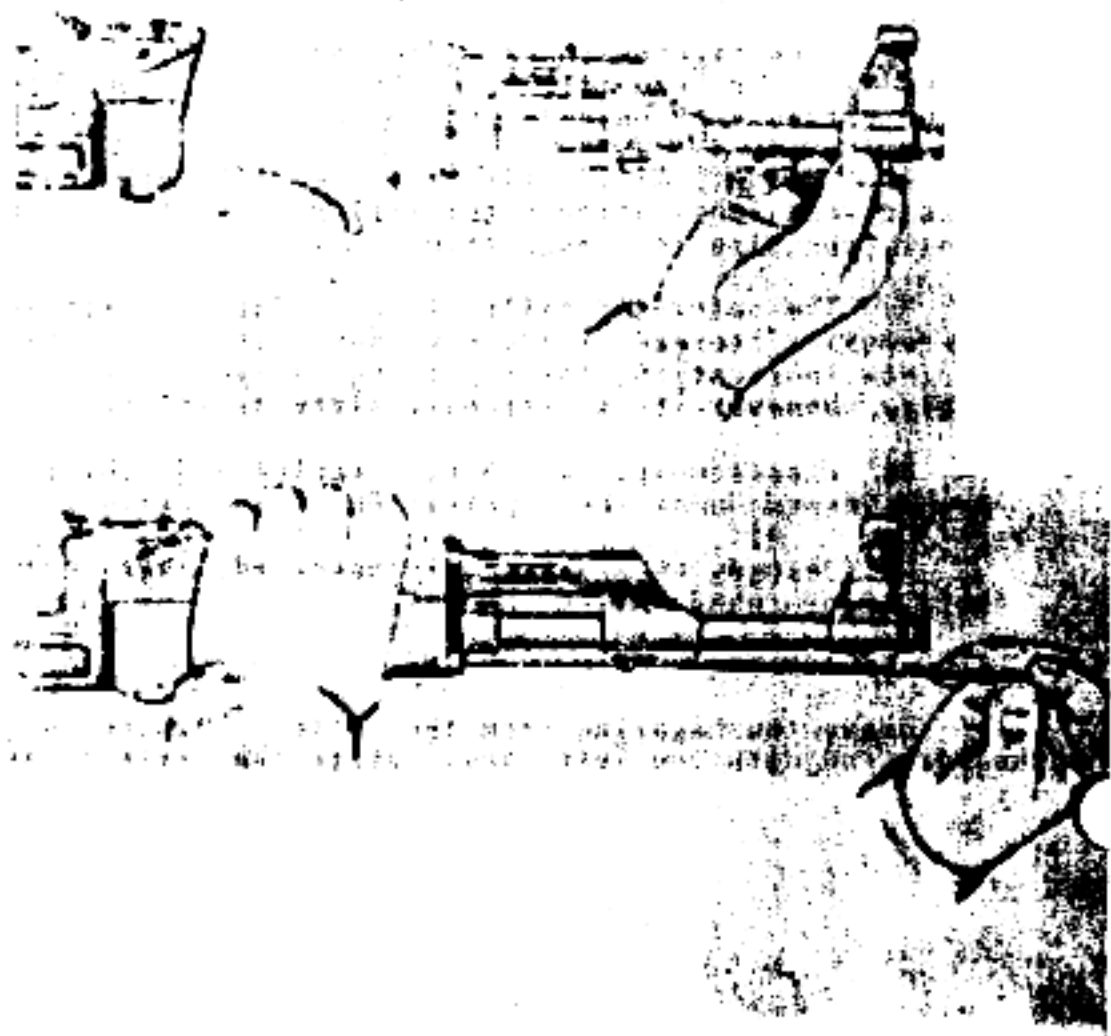

Figure 65. Removing the cleaning rod from the rifle.

amount, pushing the magazine away. Grasp the magazine with the right hand, and, depressing the magazine catch with the thumb of the right hand, rotate the magazine forward and remove it from receiver hole (fig. 64).

2. Take the rifle off safety. Rotate the selector indicator downward as far as possible with the thumb of the right hand.

3. Check to see that there is no round in the chamber. Pull the operating rod to the rear and inspect the chamber and bolt face.

4. Remove the case with accessories from the stock. Depress the butt plate cover with the index finger of the right hand and remove the case with accessories from the stock; remove the accessories from the case.

5. Remove the cleaning rod from the rifle. Place the stock of the rifle on the ground and hold in this position by means of the hand guard and fore end; take the cleaning rod with the fingers of the right hand and, bending it slightly, remove the cleaning rod head from the stop in the base of the front sight; move the cleaning rod upward so that its head leaves the forward face of the base of the front sight; remove the cleaning rod with the right hand (fig. 65). It is permitted to use a punch to remove the cleaning rod.

6. Remove the receiver cover. Lean the rifle against a table and, holding the rifle by the forward part of the butt with the right hand, depress the guide face with the thumb into the cover hole, and raise the cover with the left hand (fig. 66).

7. Remove the return mechanism from the rifle. Holding the rifle by the forward portion of the receiver with the left hand, move the return spring guide forward until its rear face leaves the groove in the receiver rear plate; lift the guide rear face and remove the return mechanism from the operating rod channel (fig. 67).

The return mechanism may also be removed by placing the rifle on a table. In this case the rifle is held by the pistol grip with the left hand.

8. Remove the operating rod with bolt from the receiver. Holding the rifle by the forward portion of the receiver with the left hand, and the cocking handle with the right hand, bring the operating rod with bolt to the rear as far as



Figure 66. Removing the cover from the receiver.



Figure 67. Removing the return mechanism from the operating rod.

possible, and, moving the operating rod forward a distance of 1 to 2 mm, raise its rear portion; bringing the operating rod to the rear, remove it together with the bolt from the receiver.

The operating rod with bolt may also be removed by placing the rifle on a table. In this case, the rifle is held by the pistol grip with the left hand.

9. Remove the bolt from the operating rod. Take the operating rod in the left hand with the cam surface facing upward, and rotate the bolt a small amount with the right hand so that the guide lug leaves the wide part of the variable groove in the operating rod, and then move the bolt to the rear as far as possible; rotating the bolt, remove its guide lug from the variable groove of the operating rod and remove the bolt from the operating rod by moving it forward (fig. 68).

10. Remove the gas tube with hand guard from the barrel. Holding the rifle by the forward portion of the receiver with the left hand, rotate the lock lever upward with the right hand; rotate the gas tube upward by means of the rear end of the receiver and remove it from the gas cylinder.

22. ASSEMBLY AFTER FIELD STRIPPING

The rifle is assembled after field stripping in reverse order.

1. Attach the gas tube with hand guard to the barrel. Holding the rifle by the forward portion of the receiver with the left hand, install the gas tube on the gas cylinder with the right hand and depress the rear end of the gas tube as much as possible; rotate the gas tube lock downward so that the lever lock enters the recess in the right wall of the rear sight base.

2. Attach the bolt to the operating rod. Grasp the operating rod with the left hand with the cam surface upward, and with the right hand install the bolt in the operating rod channel so that the rear cylindrical portion is in the operating rod lug; rotate the bolt so that the guide edge enters the variable groove in the operating rod, and then move the bolt forward (fig. 69).

3. Install the operating rod with bolt in the receiver. Hold the rifle by the forward portion of the receiver with the left hand, and with the thumb of the right hand, hold the bolt in the forward position, then insert the piston into the gas

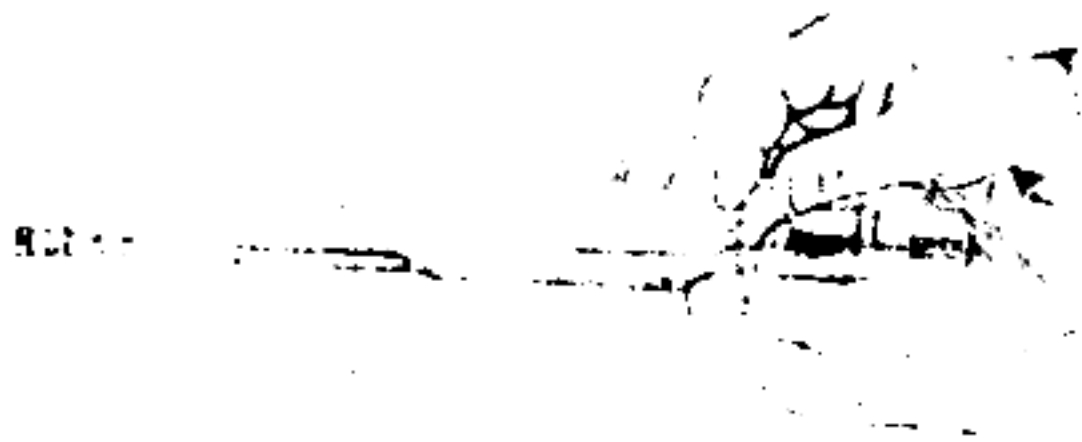

Figure 68. Removing the bolt from the operating rod.

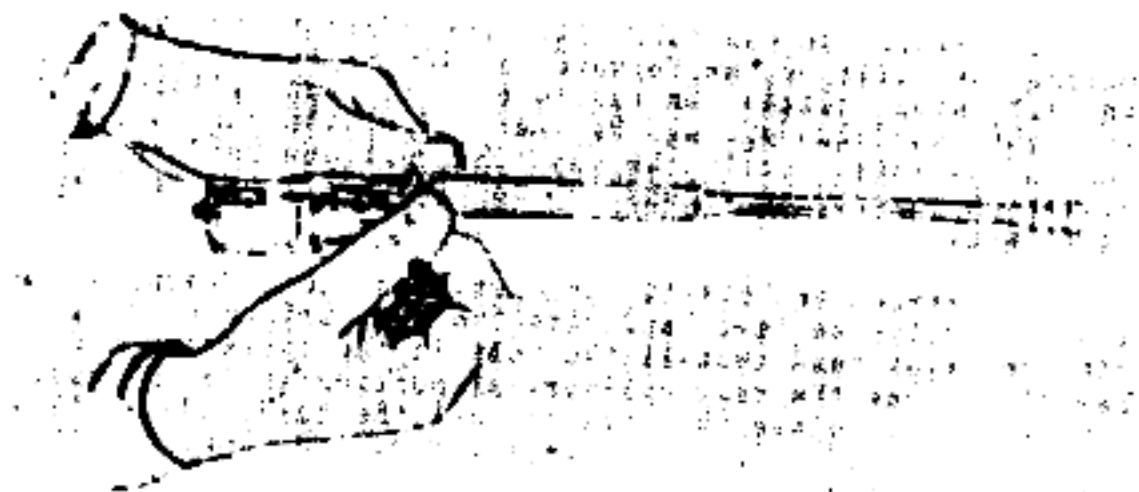

Figure 69. Attaching the bolt to the operating rod.

tube and insert the operating rod with bolt into the receiver so that the guide lugs of the operating rod and the lugs of the bolt are opposite the notches in the guide on the receiver; depress the rear portion of the operating rod so that its guide grooves coincide with the guide, and move the operating rod to the extreme forward position (fig. 70).

4. Install the return mechanism in the operating rod. Hold the rifle by the forward portion of the receiver with the left hand, and with the right hand insert the return mechanism into the operating rod channel (fig. 71), move the guide tube rear face forward and, placing its guide lugs opposite the grooves in the receiver rear plate, depress the guide tube rear face; in this position, the rear face should enter the groove in the receiver rear plate.

5. Install the cover on the receiver. Hold the rifle by the forward portion of the receiver with the left hand, and with the right hand insert the cover so that its forward face enters the semicircular groove in the rear sight base and move the cover forward as far as possible; press the rear portion of the cover forward and downward, thus completing the installation (fig. 72).

6. Install the cleaning rod in the rifle.

7. Insert the accessories into the case and insert the case into the recess in the butt.

8. Install the magazine on the rifle. Hold the rifle by the fore end with the left hand, and rotate the rifle a certain amount; insert the upward forward portion of the magazine into the hole in the receiver with the right hand so that the magazine catch enters the notch in the receiver; rotate the magazine to the rear so that the catch is engaged by the magazine stop.

9. Release the hammer from the semiautomatic sear, and turn on the safety, rotating the selector indicator upward.

23. DETAIL STRIPPING

Detail stripping of the rifle is a continuation of field stripping.

Detail stripping is performed in the following manner: field strip the rifle as instructed in section 21, and then perform the following:



Figure 70. Attaching the operating rod with bolt to the receiver.

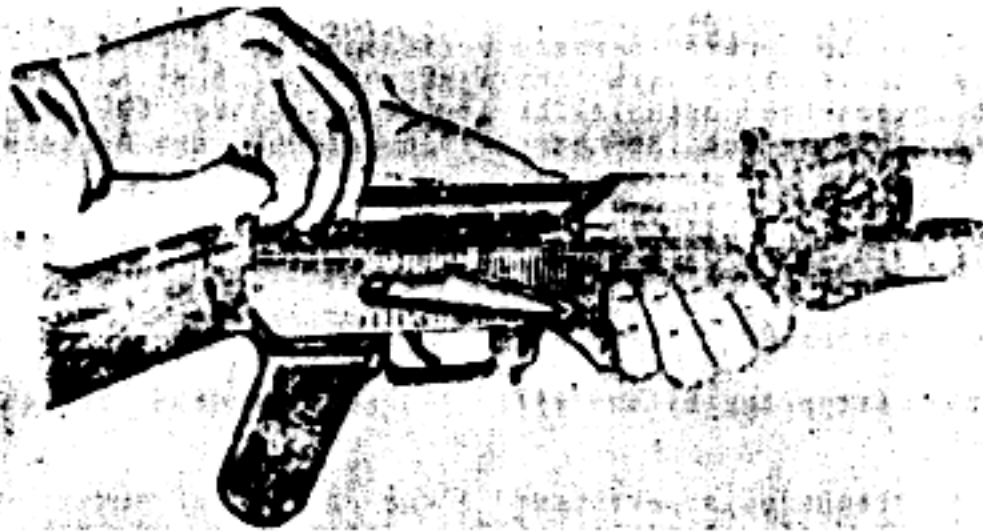

Figure 71. Attaching the return mechanism to the operating rod.

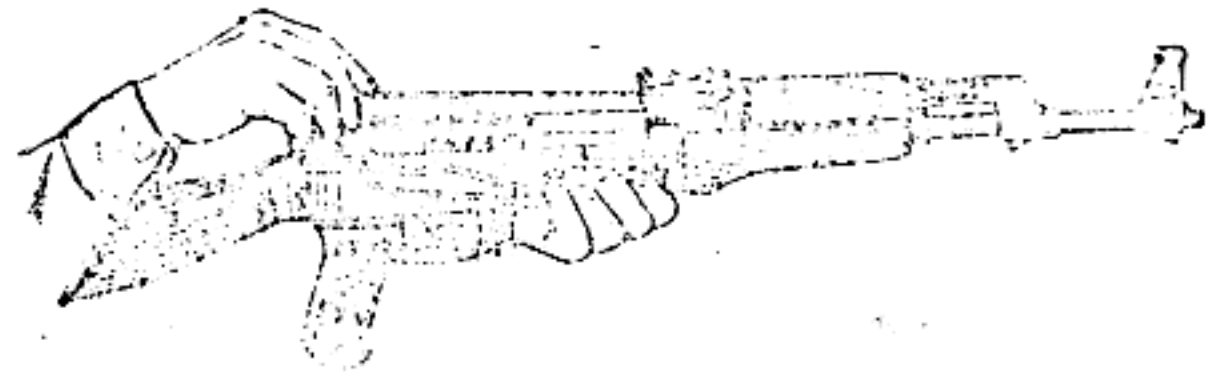

Figure 72. Attaching the cover to the receiver.



Figure 73. Disassembly of the return mechanism.

1. Disassemble the return mechanism.

Insert the cleaning rod into the guide tube until the cleaning rod head is stopped by the guide rod, and place the cleaning rod against a table.

Compress the return spring with the left hand and remove the washer from the guide rod with the right hand (fig. 73).

Remove the return spring from the rifle and remove the guide rod from the guide tube.

2. Disassemble the bolt.

Grasp the bolt with the left hand with the feed lever upward, and with the right hand remove the firing pin pin from the bolt body using a punch.

Remove the firing pin from the bolt.

Holding the extractor with the thumb of the left hand, remove the extractor pin, using a punch.

Remove the extractor and extractor spring from the recess in the bolt body.

3. Disassemble the firing and trigger mechanism.

Remove the stop end of the full automatic sear spring from the trigger pin by means of a punch.

Punch the trigger pin to the left using the punch, then remove the trigger with disconnector and spring from the receiver.

Separate the disconnector from the trigger and remove the semiautomatic sear spring from its recess.

Rotate the selector indicator upward until the lug on the lever coincides with the notch in the wall of the receiver hole, and separate the selector from the receiver (fig. 74).

Depress the stop end of the full automatic spring, using a punch or wooden rod, and punch out the hammer pin to the left by means of a punch; remove the hammer and hammer and trigger spring from the receiver, and remove the hammer.

Punch out the full automatic sear pin to the left using a punch; remove the full automatic sear and sear

spring from the receiver, and remove the spring from the sear.

In combat units, the firing and trigger mechanism is disassembled for the purpose of changing lubrication, under the supervision of an armorer-artificer.

In the event the firing and trigger mechanism becomes dirty, the rifle is cleaned and lubricated without disassembling it.

NOTE: In the automatic rifle with stamped receiver, the firing and trigger mechanism may be disassembled in the artillery workshop only for the purpose of repair or replacement of parts.

4. Remove the fore end from the barrel.

Hold the forward portion of the hand guard with the left hand, and with the right hand rotate forward as far as possible the fore end band lock indicator by means of a punch, and move the stop band toward the gas cylinder.

Move the fore end forward with the right hand so that its lug on the rear face is disengaged from the recess in the receiver, and then disengage the fore end by pulling downward.

Further disassembly of the rifle is performed in the artillery repair shop.

24. ASSEMBLY AFTER DETAIL STRIPPING

1. Attach the fore end to the barrel.

Hold the rifle by the forward portion of the receiver with the left hand, and with the right hand insert the fore end so that its lug on the rear face enters the recess in the receiver, and move the fore end forward as far as possible.

Mount the band on the fore end shoulder as tightly as possible, and rotate the lock to the rear so that its indicator enters the notch on the band.

If the lock indicator does not rotate to the rear, it is necessary to move the band along the barrel, and at the same time to press upward on the lock indicator, in this manner aligning the lock with the recess in the barrel, and then rotate the lock.

2. Assemble the firing and trigger mechanism.



Figure 74. Removing the selector from the receiver.

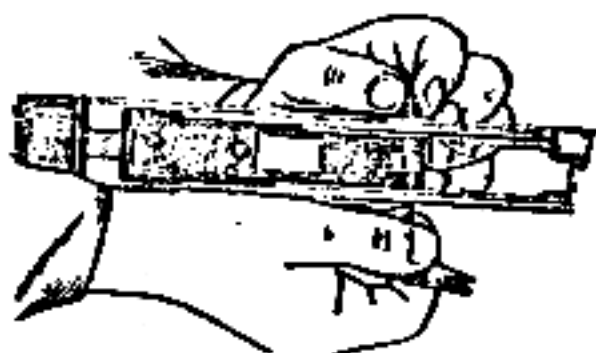

Figure 75. Installing the full automatic sear pin.



Figure 76. Installing the hammer with hammer and trigger spring to the receiver.

Attach the full automatic sear spring to the full automatic sear and insert the sear with spring into the receiver so that the stop end of the spring points to the rear.

From the right side of the receiver, insert the punch into the hole for the full automatic sear pin.

Insert the full automatic sear pin into the hole from the left side of the receiver and, while continually removing the punch, install the full automatic sear pin (fig. 75).

Mount the hammer and trigger spring on the hammer pins and insert the hammer with hammer and trigger spring into the receiver (fig. 76).

Insert the punch in the hole for the hammer pins from the right side of the receiver.

Insert the hammer pin into the hole through the left side of the receiver, and press back the stop end of the full automatic sear spring with the pin; while removing the punch, insert the hammer pin (fig. 77) and place the stop end of the full automatic sear spring into the recess in the pin.

Assemble the selector to the receiver and set it on semiautomatic fire.

Install the disconnecter and disconnecter spring into the trigger groove and insert the trigger and sear into the hole in the receiver (fig. 78).

Through the right side of the receiver, insert the punch into the hole for the trigger pin, after raising the stop end of the full automatic sear spring.

Insert the trigger pin into the hole through the left side of the receiver; while removing the punch, install the trigger pin and set the stop end of the full automatic sear spring in the recess in the pin.

Raise the ends of the hammer and trigger spring by means of the punch and place the bent ends of the spring on the rear shoulders of the trigger.

3. Assemble the bolt.

Insert the extractor and spring into the bolt recess; depress the extractor with the thumb of the left hand to set it in the recess; set the extractor pin in the hole with the right hand so that the notch on the upper end of the pin is turned in the direction of the rear cylindrical portion of the bolt body. (See fig. 79).

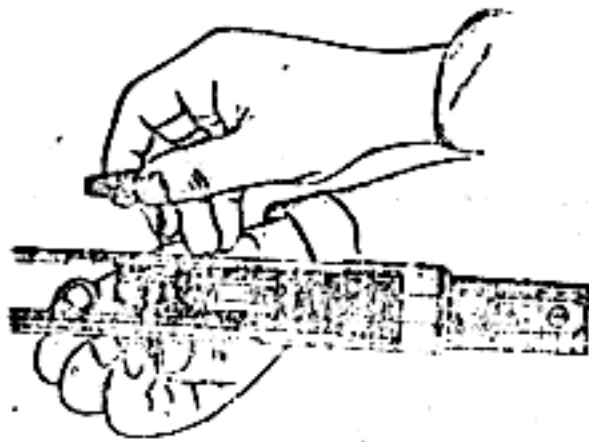

Figure 77. Installing the hammer pin.



Figure 78. Installing the trigger with disconnecter in the receiver.



Figure 79. Installing the extractor pin in the bolt.

Insert the firing pin into the bolt so that the recess in the firing pin is aligned with the hole for the pin (fig. 80); in order to control the position of the firing pin in the hole for the firing pin retaining pin, it is necessary to insert the punch from the side of the feed lever so that the firing pin can rotate and interfere with the installation of the firing pin retaining pin.

Insert the firing pin retaining pin into its hole.

4. Assemble the return mechanism.

Insert the guide rod into the guide tube.

Insert the cleaning rod into the guide tube until the cleaning rod headbutts against the guide rod and, pressing the cleaning rod against the table, install the return spring.

Compress the return spring with the left hand, and with the right hand install the washer on the guide rod (fig. 81).

Further assembly of the rifle is performed by following the order given in Section 22.

25. DISASSEMBLY OF THE MAGAZINE

Remove the cover plate from the magazine. Grasping the magazine in the left hand, depress the stop plate (fig. 82) by means of the punch (through the hole in the cover plate) and move the cover plate so that the stop lug is disengaged from the hole in the cover plate; hold the stop plate with the thumb of the left hand and remove the cover plate with the right hand.

Remove the cover plate with spring and follower from the magazine. Release the stop plate and remove the spring together with the stop plate and follower from the magazine.

Remove the follower and stop plate from the spring.

26. ASSEMBLY OF THE MAGAZINE

Assemble the follower and stop plate to the spring.

Insert the spring with follower and stop plate in the magazine. Grasp the magazine with the left hand (cover plate upward, rear groove inward), and with the right hand insert the spring with follower and stop plate in the magazine.

Attach cover plate to magazine. Depress the stop plate in the magazine body and, holding it with the thumb of the



Figure 80. Installing the firing pin in the bolt.



Figure 81. Assembly of the return mechanism.



Figure 82. Removing the cover plate from the magazine.



Figure 83. Installing the spring with follower and stop plate to the magazine.

left hand, move the cover plate onto the flanges of the magazine body (fig. 84) with the right hand until the lugs of the cover plate press against the rear wall of the magazine.

27. DISASSEMBLY AND ASSEMBLY OF THE AUTOMATIC RIFLE IN REPAIR SHOP

In addition to detail and field stripping and assembly, disassembly and assembly of the pistol grip, sights, and butt are also performed in the repair shop.

Disassembly

1. Remove the pistol grip from the receiver. Loosen the screw by means of the screw-driver and remove the pistol grip from the receiver.

2. Disassemble the wooden butt.

Knock out the butt screw with the punch and remove the butt from the receiver.

Unscrew the rear screws with the screw driver and remove the clamp from the butt.

Unscrew the screws in the butt plate with the screw driver, and remove the butt plate and cover plate from the butt.

2a. Disassemble the folding metal stock.

Knock out the nut pin with the punch and remove the nut from the stock.

Knock out the stock catch pin through the hole in the base of the receiver using the punch and remove the catch plunger with spring from the stop pin.

Move the stop pin to the left so that the ends of the stop pin of the pin leave the notches in the wall of the receiver, and remove the stop pin from stock pin hole.

Remove the stock pin from the hole in the receiver and remove the catch from the receiver; remove the bars from the receiver.

Remove the swivel base from the stock pin.

NOTE: The folding metal stock of automatic rifles with stamped receiver is to be disassembled only in exceptional circumstances for repairing and replacing parts.



Figure 84. Installing cover plate in the magazine.

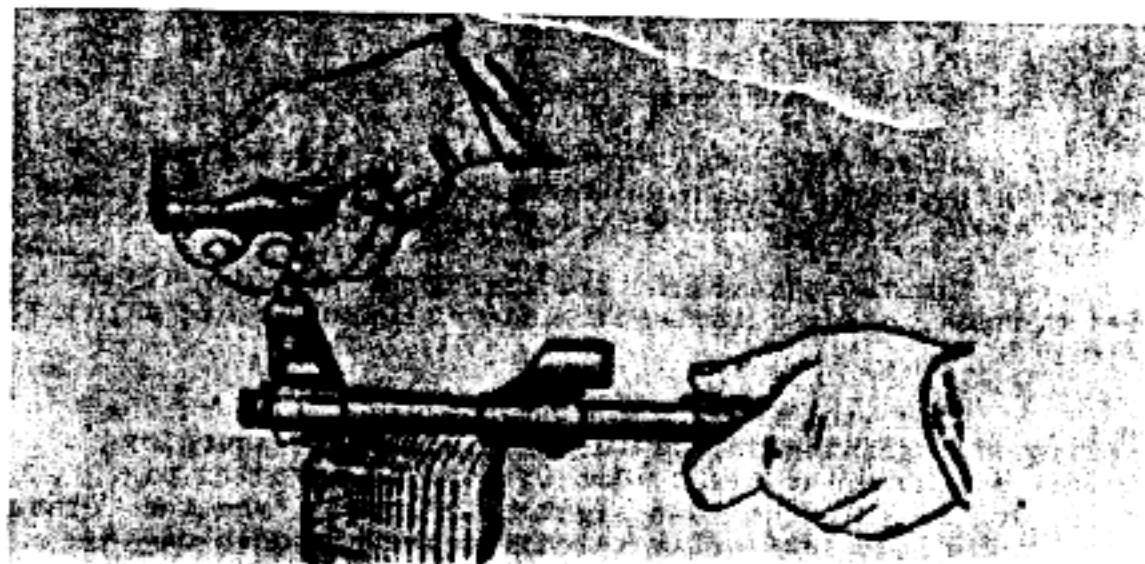

Figure 85. Removing the front sight from the stud.

3. Remove the front sight from the front sight stud. Hold the rifle by the barrel with the left hand, unscrew the front sight from the front sight stud using the screw-driver, rotating the screw-driver in the counter-clockwise direction.

4. Remove the front sight stud from the front sight base. Place the muzzle of the rifle on a table or wooden stand and knock out the front sight stud using a punch or wooden rod (fig. 86).

NOTE: The front sight and stud are to be removed only for repair. After installing the front sight and stud, it is necessary to check the accuracy of the rifle.

5. Disassemble the rear sight.

Hold the sight leaf at an angle of 40 to 50 degrees and press on the forward end of the sight leaf using a punch or wooden rod, and move the sight leaf to the rear until the pins leave the holes in the rear sight base lug.

Using a punch and hammer, knock out the sight leaf spring from the grooves in the sight base, and remove the spring from the sight base.

Press on the slide catch, move the slide along the sight leaf and remove it, and remove the catch and catch spring from the recess in the slide.

Assembly

1. Assemble the rear sight.

Insert the catch spring and catch into the slide recess and, while pressing on the catch, install the slide on the sight leaf and move it to the rear as far as possible.

Install the sight leaf spring in the rear sight base grooves, holding the sight leaf at an angle of 40 to 50 degrees.

Place the forward end of the sight leaf on the spring and, pressing on the forward end with a punch or wooden rod, move the sight leaf forward so that its pins enter the holes in the rear sight base lugs. Free the forward end of the sight leaf after releasing the pressure on it.

2. Assemble the front sight.

Insert the front sight stud into the base hole until the alinement marks coincide.



Figure 86. Removing the stud from the front sight base.

Screw the front sight into the stud base, using the screw-driver.

3. Assemble the folding metal stock.

Install the swivel base on the stock pin.

Attach the bars to the receiver and insert the catch into the receiver.

Insert the stock pin into the hole in the left bar and the hole in the left wall of the receiver, and mount the catch on the pin.

Insert the stop pin into the hole for the stock pin, and the pin into the hole in the right wall of the receiver so that the end of the stop pin enter the notches in the right wall of the receiver.

Install the nut on the stock pin and insert the nut pin.

Insert the spring and the catch plunger in the stock pin and, alining the holes in the plunger with the holes in the catch, install the pin.

4. Assemble the wooden butt.

Insert the accessory case spring into the recess in the butt.

Attach the butt plate cover and the butt plate to the butt and replace the screws.

Mount the clamp on the butt face and replace end screws.

Attach butt to receiver and replace butt pins.

CHAPTER 4

INSPECTION OF THE AUTOMATIC RIFLE

28. GENERAL

For timely discovery and removal of defects in automatic rifles, and also of irregularities in their storage and care, the automatic rifles are inspected according to the instructions given in the unit interior economy regulations.

The technical condition of automatic rifles is characterized by their readiness for combat employment and, in addition, by the degree of their wear as a result of use.

Depending upon the degree of wear and character of repair required, automatic rifles are divided into categories according to the "Instructions for Classifying Artillery Materiel."

29. DAILY INSPECTION OF THE AUTOMATIC RIFLE BY THE SOLDIER

The rifle is inspected daily before leaving for a detail, before exercises, before firing, after firing, upon returning from a detail, and while cleaning.

The rifle is inspected daily in the assembled form, and in the assembled and disassembled forms while cleaning. The accessories are inspected before each cleaning. The soldier is required to report immediately to his commander (squad leader) when he discovers irregularities in his inspection of the rifle, magazines, and accessories.

The following points are checked in the daily inspection of the rifle:

Metal parts for rust, dirt, deep scratches and cracks (particular attention is to be paid to cleanliness of the chamber, bore, and bolt face).

The stock (of automatic rifles with wooden butt), fore end, hand guard and pistol grip, for cracks, splits, or serious indentations.

The bolt, operating rod, return and firing and trigger mechanisms, for proper operation when the selector is set for semiautomatic and automatic fire; magazine lock, stock catch (of automatic rifles with folding metal stock), selector indicator, for condition; end screws and rear swivel screws (of automatic rifles with wooden stock) for looseness.

The hammer, to see that it is not cocked, and the position of the safety.

The front sight and rear sight, for condition, and the rear sight leaf notch for cleanliness.

Presence of accessories in stock recess, butt plate cover (of automatic rifles with wooden stock) to see that it closes properly; presence and condition of accessories in magazine bag (of automatic rifles with folding metal stock).

The sling for proper connection.

The magazines for proper assembly and functioning, and the position of the magazine in the rifle.

30. INSPECTION OF THE AUTOMATIC RIFLE, ASSEMBLED

The rifles are inspected in the assembled form in all phases of inspection.

The following items are checked in inspecting the rifle:

Serial number on the receiver cover and serial number on receiver for correspondence.

Metal parts for rust, scratches, dents and cracks, and fore end, hand guard, pistol grip and butt, for cracks, slits, and deep nicks.

End screws, pistol grip screw, and also lower swivel and butt plate screws (of rifles with wooden butt).

Receiver and receiver cover, for cracks and deep dents. In addition, during inspection the general condition of the rifle is checked.

The front sight should be vertical and should not move in the stud holes during fire, and the front sight stud should not move in the base by pressure of the hand; the line on the stud should coincide with the line on the front sight base.

The barrel bushing should be held firmly by the lock; the lock should be depressed in the recess of the front sight base easily by hand and should return quickly under the action of its spring.

The gas tube with hand guard and fore end should not have any longitudinal play.

The rear sight base should be held firmly on the barrel. Longitudinal play of the sight leaf is permitted under the condition that the sight leaf return to the initial position after being moved to the side by hand.

The sight leaf should return to the initial position under action of the spring from any position within the limits of 30 degrees with respect to the rear sight base.

The lines and figures on the sight leaf should be clearly legible. When the catch is depressed, the slide should move freely along the entire length of the sight leaf.

The slide catch should be depressed easily into the slide recess without jamming and should return quickly to the initial position under the action of its spring.

The lock spring should firmly lock the slide at any graduation on the sight leaf.

The sight leaf notch should be without nicks and burrs.

The lock should firmly hold the gas tube and hand guard and should lock itself in the closed position.

The receiver cover should be firmly held by the guide rear face lug, and the rear face should move forward freely when its lug is pressed by the finger, and should move to the rear quickly under the action of the return spring when the lug is released.

The pins of the full automatic sear, hammer, and trigger should be held firmly in their holes.

The selector should rotate freely when changed from one position to the other, and should be firmly held in any one of the following positions: semiautomatic, full automatic, and safety.

When the selector is set on safety, and the hammer is released from the top position, the trigger should not rotate when depressed, and the operating rod should be limited in its rearward movement by the hammer.

When the selector is set on safety, and the hammer is cocked, the trigger should not rotate when depressed, and rearward motion of the operating rod should be limited by the selector indicator, the forward end of which should butt against the cocking handle.

The magazine lock should rotate easily on its pin when its lower end is pressed and should return to the original position quickly under the action of the spring; the magazine lock should firmly hold the magazine in the receiver.

The catch should not be bent, and its upper face should not be damaged by dents. The ends of the catch pin should be flattened out, and the pin should be held firmly in the hole.

The wooden butt should not have any cracks, splits, or deep dents. Between the faces of the clamp and the butt there should be a clearance.

There should be no play of the butt in the clamp, and also in the receiver.

The end screws, swivel screws, and butt plate screws should be screwed in as far as possible.

The butt plate cover should seal the recess for the accessories firmly, and should open easily without effort by the pressure of the finger. When the butt plate cover is closed, the accessory case should be pressed tightly against the cover. When the cover is open, the accessory case should be ejected quickly by its spring to be removed by the hand.

The accessory case spring should be held firmly in the recess and should not fall out when the rifle is manipulated (when the accessory case is not in the butt).

The folding metal stock should not have bent bars, and the swivel ring should be held firmly in the swivel base and should not be bent.

A small amount of lateral play of the stock and also a small amount of play of the lower ring of the shoulder support with respect to the axis of rotation is permitted. The shoulder support should rotate easily on its pins by pressure of the hand and lock firmly in the service position.

The ends of the shoulder support pins should be flattened out and held firmly in the lugs of the bars.

The stock catch should lock the butt firmly in the service and travel positions.

When the stock is moved to prepare the rifle for the service or the travel position, the bars should rotate easily by pressure of the hand and should not be caught by the protruding parts of the rifle (magazine, fore end, and selector).

The pistol grip should be held firmly on its base without play, and should have no cracks or deep dents.

The firing and trigger mechanism should be checked for proper operation.

Set the selector on semiautomatic fire, depress the trigger and, holding the hammer in the depressed position, pull the operating rod to the rear and release it; the hammer should not be released from the cocked position; release the trigger; a click should be heard when the latter is done (caused by the hammer moving from the semi-automatic fire position to the cocked position); when the trigger is depressed once more, there should be heard another click (hammer striking the firing pin).

Set the selector on full automatic fire, pull the operating rod to the rear and release it. The operating rod should move to the rear freely and quickly return to the forward position under the action of the return spring; when the trigger is depressed, the hammer should quickly strike the firing pin. Without releasing the trigger, pull the operating rod to the rear and slowly return it to the forward position, while holding it with the hand; when the operating rod is a distance of 3 to 6 mm from the extreme forward position, the full automatic disconnecter should rotate the full automatic sear, and the hammer should quickly strike the firing pin.

Check the operation of the bolt, operating rod, return mechanism, using a magazine which is filled with drill rounds.

The operating rod should move to the rear easily without jamming and irregular motions, and move forward quickly under the action of the return spring, and at the same time the bolt should grasp the next drill round and feed it into the chamber; the next round in the magazine should be raised to the stop in the lower round portion of the operating rod lug. When the bolt approaches the barrel, the extractor lug should pass over the cartridge case flange. When the operating rod is pulled to the rear a second time, the round, striking the ejector, should be ejected and extracted from the receiver, and the next round should be fed under the flanges of the feed mechanism.

If the operating rod is pulled to the extreme rear position and moved upward vertically, it should press against the guide of the return spring; if the operating rod is released in this position, it should return quickly to the forward position under the action of the return spring without jamming.

31. INSPECTION OF AUTOMATIC RIFLE, DISASSEMBLED

The rifles are inspected in the disassembled form in the presence of an officer.

In such an inspection, all the parts must be cleaned and dried thoroughly, paying particular attention to the cleanliness of the bore.

In the inspection, particular attention must be paid to see that the receiver, receiver cover, operating rod, bolt and return mechanism all bear the same serial number. The firing and trigger mechanism is not disassembled for this inspection.

Inspection of the Barrel, Gas Cylinder, and Fore End Band

The breech and muzzle faces of the barrel, and the extractor notch, should be clean; no dents are permitted on them.

To inspect the bore, the barrel is raised to the level of the eyes and directed at a source of light; the barrel is inspected through the breech end and through the muzzle end; then the chamber is inspected. The barrel must be rotated when the bore is being inspected.

The barrel should be held at a distance of 50 to 70 mm for best visibility.

The following may be discovered when inspecting the bore:

Rust in various places along the entire bore. If rust is present, a dark deposit can be seen on the cleaning patch.

Coppering, which appears as a result of extensive firing and insufficient cleaning; it is observed in the form of a copper deposit on the surface of the bore.

Near of the lands, which occurs most often at the origin of the rifling and at the muzzle.

Bulged barrel, which occurs in the bore in the form of a transverse dark ring; in this case the serviceability of the rifle is decided by the chief of artillery armament of the unit.

Bending of the barrel, which is determined by improper position of the shadow in the bore (fig. 87).

In order to determine bending of the barrel, the barrel is brought under any horizontal lower edge of an object (window ledge, board, etc.). In a straight barrel there should be seen a shadow in the form of an equilateral triangle, the base of which is located in the center of the bore; the shape of the triangle should not change when the barrel is rotated.

In a bent barrel, the sides of the triangle are curved and their curvature changes with rotation of the barrel about its axis. If the bending is acute, the shadow triangle is broken, or its sides are displaced with respect to each other.

Near of the barrel bore is checked by gage K-2, which should not enter the bore through the muzzle face a distance greater than 7.62 mm. This distance may be exceeded only under the condition that the rifle satisfies the requirements for accuracy in firing.

The bore is chrome-plated. Chrome-plated barrels have a number of peculiarities which do not affect the properties of the rifle in any adverse manner.

These peculiarities are a dull bore surface and a circular darkening of the bore, spiral formations, erosion patterns, and flaking of the chromium. The dull surface, circular darkening and spiral formations may be found in new barrels as well as used barrels.

The dull bore surface is characterized by a local darkening of the bore which is not any form of rust.

The circular darkening may be formed in the entire circumference of the bore or a part of the circumference, but in the chrome-plated barrel this is not bulging and is not considered a defect.

Spiral formations on the chrome-plated bore occur as a result of mechanical finishing of the bore (in manufacture). Before the chrome-plating process, the results of the polishing process are not visible; after the chrome-plating process, the results of polishing are seen in greater relief in the form of these spiral formations.

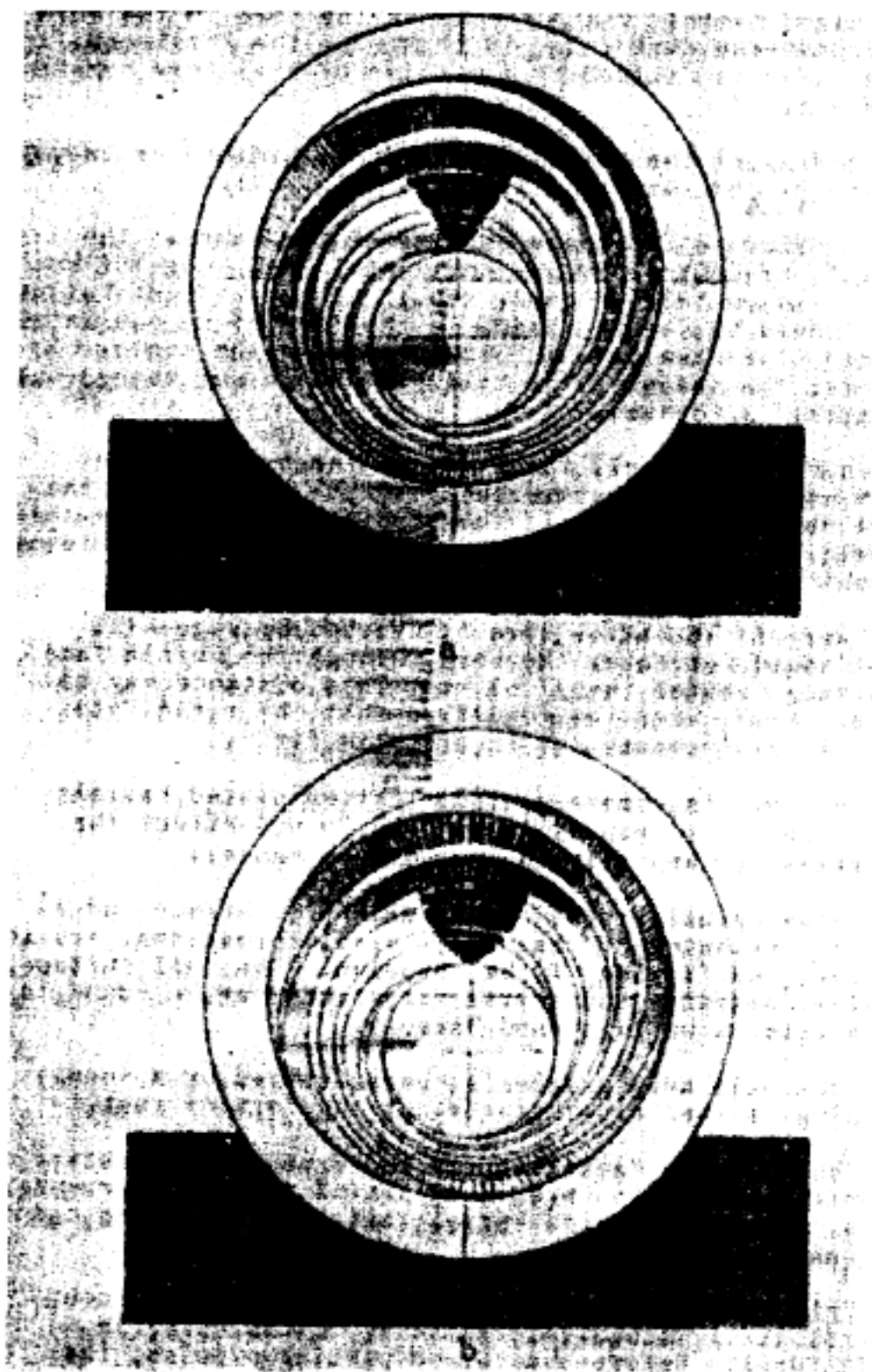

Figure 87. Triangular shadow in the base.

A. In straight barrel; B. In bent barrel.

An erosion pattern is observed in the form of intersecting stripes on the surface of the bore, as a rule in the breech end. These stripes appear as the weapon is in use. With an increase in the number of rounds fired, there are cracks formed in the stripes and chipping of the chromium takes place, first in the form of points and then in the form of slivers of chromium.

Chipping off of chromium is the most obvious form of erosion of the chrome-plated surface in the breech and occurs as a result of intense erosion.

The erosion patterns and chipping off of chromium are unavoidable in chrome-plated barrels, and cannot be considered a shortcoming of the bore, since with their appearance the barrel retains its accuracy of fire.

Bores with an erosion pattern require more intensive cleaning.

The gas cylinder should not have rust, erosion, burrs, or dents on the guide face, or nicks in the lug for attaching the cleaning rod.

The fore end band should not be bent, and the hole for passing the cleaning rod should not have any nicks; the lock should rotate freely by effort of the hand; the band should move freely along the barrel when the lock indicator is rotated forward, and should be held firmly on the barrel without play when the indicator is rotated to the rear.

Inspection of the Receiver and Receiver Cover

The receiver should not have cracks, dents, deep scratches, nicks, burrs, and raised points of metal in the guides for the operating rod, the guides for the bolt, rear face of the cam surface, screw bevel of the cam surface, and the locking lugs. In the ejector there should not be dents, cracks, or irregular portions of metal.

The trigger guard and pistol grip base should be held firmly; the rivets must not lose their grip.

The receiver cover should not have cracks, dents, or nicks in the walls of the ejection and cocking handle port.

The forward face of the receiver cover should require a certain amount of effort to be inserted in the semicircular groove in the rear sight base.

Inspection of the Bolt, Operating Rod, and Return Mechanism

In the bolt there should be no cracks, dents, chips, or raised portions of metal, especially in the locking and guide lugs.

A certain amount of erosion of the bolt face around the hole for the firing pin head is permitted. The firing pin should move in the bolt under the action of its own weight; when the firing pin is moved forward as far as possible, its rear face should not project beyond the rear face of the bolt, and when it is moved to the rear as far as possible, the tip should not project beyond the base of the bolt face.

Under the action of the spring, the extractor should quickly strike the center of the bolt face with its lug; the drill round, inserted into the bolt face, should press against the face rim with the ejector and be held firmly in the bolt.

There should be no cracks or chipping of metal in the extractor lug. The extractor spring should not be damaged and should have no less than five coils.

The extractor pin should be inserted into the hole freely by the effort of the hand and should be held firmly in it by the pin of the firing pin.

The firing pin retaining pin should be held firmly in the hole.

The operating rod should not have cracks, dents, burrs, and chipping of metal, especially in the guide grooves, the full automatic sear selector, the rear face lug, and the walls of the cam surface.

When connected with the operating rod, the gas piston rod may have a small amount of free play; the gas piston rod pin should be held firmly in the hole in the operating rod, and the ends of the pin should be flattened out (peened) and smooth.

The gas piston should have no dents, burrs, chipping or raised portions of metal (especially in the forward face).

The return spring should have not less than 80 coils; it should move freely on the guide tube and the guide rod without jamming until the coils come into contact. In the guide tube there should be no dents and burrs, and the guide rod should not be bent. The return spring with guide tube and rod should be easily inserted into the operating rod channel and be firmly held by the guide tube rear face in the grooves of the receiver rear plate.

Inspection of the Firing and Trigger Mechanism and Check of Operation

The trigger should rotate freely on its pins and the tail should not be bent; cracks and burrs on the cock notch are not permitted.

The hammer should have no dents, chipping, or noticeable rounding on the cock notch and full automatic sear notch. The full automatic sear should have no dents, chipping or rounding of the sear, and the upper end of the full automatic sear lever should not be bent or have any dents.

The disconnecter should have no chipping or rounding off of its lug; under the action of the spring, the sear should rotate quickly on its axis.

The selector should be held firmly in any of its three positions, and should have no cracks, dents, or burrs in the forward end of the indicator or rounding off of the lock.

After inspection of the firing and trigger mechanism, it is necessary to check its operation.

Operation is checked as follows:

1. Release the hammer: bring back the upper end of the full automatic sear lever using a punch or wooden rod, and then press the trigger; the hammer should be released and rotate on its axis under the action of the hammer and trigger spring.
2. Set the selector on safety. The lug on the lever should be located above the right rear shoulder of the trigger and above the tail of the disconnecter and should firmly limit their rotation on the pin. When the hammer is cocked, the hammer should not engage the full automatic sear of the trigger cock notch, but should butt against the semiautomatic sear with the rounded portion of its head.
3. Set the selector on semiautomatic fire. The lug on the selector lever should move to the rear the amount necessary to prevent rotation of the trigger and the disconnecter.

Press the trigger. Rotate the hammer to the rear as far as possible with the hand, and the hammer should engage the disconnecter. The disconnecter lug should engage the notch a distance not greater than 1.8 mm.

Release the trigger; the hammer should be released and engage the full automatic sear. Bring back up the upper end of the full automatic lever using a punch or wooden rod; the hammer should disengage from the full automatic sear and engage the semiautomatic sear.

Press the trigger; the hammer should disengage from the semiautomatic sear and quickly rotate on its pin.

4. Set the selector on full automatic. The lug on the selector base should move to the rear enough so as not to interfere with rotation of the trigger; it should be located above the disconnecter tail (but should not butt against it until the trigger is pressed) and firmly limit rotation of the disconnecter when the trigger is pressed. Press the trigger. Rotate the hammer to the rear; the hammer should engage the full automatic sear. Without releasing pressure from the trigger, move forward the upper end of the full automatic sear lever, using a punch or wooden rod; the hammer should be released from the full automatic sear and rotate quickly on its pin.

When the full automatic sear lever is moved forward, between the full automatic sear and the full automatic sear notch there should be a clearance sufficient to permit free rotation of the hammer.

When the trigger is depressed, between the disconnecter notch and the disconnecter there should be a clearance of not less than 0.5 mm. When the selector is set either on full or semiautomatic fire, the hammer should be firmly held by the full automatic sear notch until the full automatic sear lever rotates forward and its upper end is set on the level of the right guide of the bolt.

In addition, when the firing and trigger mechanism is assembled, between the full automatic sear lever and the right wall of the receiver, there should be a clearance of not less than 0.2 mm; the pins of the trigger, hammer, and full automatic sear should be firmly held by the stop end of the full automatic sear spring and should not leave their holes when pressed by a punch; the ends of the pins must not butt against the right wall of the receiver.

Inspection of the Gas Tube with Hand Guard and Fore End

The hand guard bands should be held firmly on the gas tube.

The interior surface of the hand guard should have no cracks, splits or deep dents; it should be held firmly on the gas tube; between faces of the flanges of the band and the hand guard there should be a clearance of not less than 0.1 mm.

The inside surface of the fore end should have no cracks, splits or deep dents; between the fore end and the fore end band flange there should be a clearance of not less than 0.1 mm.

There should be a clearance between the hand guard and fore end.

32. INSPECTION OF THE MAGAZINE

The walls of the magazine body and the feed mechanism flanges should not be damaged or bent and also should not have any cracks.

The magazine cover plate should attach easily to the magazine body; the stop plate should hold the magazine cover plate firmly.

The magazine catch and magazine stop should not be excessively worn, and should not be dented.

33. INSPECTION OF THE ACCESSORIES

The cleaning rod should be easy to remove and replace from the recess in the fore end. The cleaning rod should be straight; the cleaning rod is checked for straightness by raising it to the level of the eyes and rotating it; the thread for the jag should not be damaged.

The screw-driver should not be dented or chipped; the blade should always be inserted so that it corresponds to the notches in the screw.

The front sight key should have no dents or burrs in the notch for the front sight. The punch should be straight; in addition, there should be no burrs on the end of the punch.

The jag should screw onto the threaded end of the cleaning rod easily and be held firmly.

The shaft of the brush should be straight, clean and even; the bristles should be elastic; the brush should screw easily onto the threaded end of the cleaning rod.

There should be no dents in the accessory case. The holes in the accessory case for the cleaning rod should not be worn.

The accessories should fit easily in the accessory case.

There should be no dents or cracks in the oil can; the oil can caps should have cork washers and should screw tightly onto the can; oil must not leak through the oil can caps, or through the oil can seams.

The magazine bag should be clean, and should have all the buttons, hooks, and hinges.

PART TWO

FIELD SERVICE AND USE OF THE AUTOMATIC RIFLE

CHAPTER 5

PREPARATION OF THE RIFLE FOR FIRE AND HANDLING OF THE RIFLE

34. GENERAL

If properly prepared for fire, the automatic rifle rarely malfunctions.

The automatic rifle is prepared for fire for the purpose of insuring faultless operation in fire and maintaining accuracy.

The following must be done to prepare the automatic rifle for fire:

1. Inspect the rifle disassembled.
2. Inspect the rifle assembled.
3. Inspect the ammunition and load the magazines.
4. After inspection, check operation of the mechanisms of the rifle in the assembled form.

Irregularities discovered in inspection must be immediately reported to the commander, and the rifle must be sent to the repair shop if necessary.

In preparation for fire, loaded magazines are not to be inserted in the rifle. Magazines which are loaded with service ammunition are to be inserted in the rifle only on the firing line. Before fire, the bore and chamber must be dried thoroughly.

After fire, the rifle is to be inspected carefully for the presence of a round.

A rifle with loaded magazine is not to be left on the firing line.

It is forbidden to practice aiming, uniform squeezing of the trigger together with pulling the bolt to the rear and releasing the hammer without drill rounds in the magazine or chamber.

35. PREPARATION OF THE AUTOMATIC RIFLE FOR FIRE

In preparing the rifle for fire, it is necessary to consider the time of year and the temperature at which the rifle will be fired. Depending upon these considerations, the proper lubrication must be used.

In preparing the rifle at temperatures of plus 50 degrees C. to minus 5 degrees C. (122°F to 23°F), it is necessary to field strip the rifle, carefully inspect, clean and lubricate the rifle with rifle lubricating oil. Then assemble the rifle and check the operation of the assembled rifle.

In preparing the rifle for fire at temperatures lower than minus 5 degrees C. (23°F), the rifle is to be detail stripped, and all parts are to be wiped dry, paying particular attention to the parts of the firing and trigger mechanism, bolt, and magazine.

Then all the parts of the rifle are to be lubricated lightly with winter lubrication No. 21. Grooves, holes and notches are to be lubricated with a patch which is immersed in oil and wound on the wooden rod. Then the rifle is assembled. The winter lubrication must be applied evenly and in a thin layer.

When the rifle is being prepared for fire after the first lubrication, if the parts of the rifle are not excessively dirty, it is necessary to field strip the rifle, clean them, and again apply winter lubrication.

If the rifle is not used at all, or used seldom, then the instructions given in Chapter 8, Section 49, are to be followed. When rifles are received with storage or factory lubrication, it is necessary to detail strip the rifles and magazines, remove all the lubrication, and then apply the proper lubrications to the parts, depending upon the temperature in which the rifle will be employed.

NOTE: The firing and trigger mechanism of automatic rifles with stamped receiver is not disassembled for cleaning. It is cleaned and lubricated in the assembled form.

36. LOADING THE MAGAZINE

Before the magazine is loaded, it must be inspected, cleaned and lubricated with the proper lubrication.

The rounds must be inspected before a magazine is loaded. It is forbidden to load magazines with defective rounds, either service or training. The magazine is loaded in the following

manner; Grasp the magazine with the left hand, follow upward, and with the right hand insert the rounds into the feed mechanism of the magazine, and, using the thumb of the left hand, force them into the magazine (fig. 88).

37. LOADING THE RIFLE

To load the rifle, follow these instructions:

1. Attach the loaded magazine to the rifle; this is done by inserting the magazine into the receiver hole and, pressing the magazine upward, rotate it to the rear as far as possible, until a click is heard indicating that the magazine catch is engaged by the magazine stop. The magazine is then rocked to check the hold of the catch.

2. Clear the opening for the cocking handle by rotating the selector indicator, and set the selector on the required fire setting, matching the end of the selector with the corresponding setting on the receiver.

3. Bring the operating rod to the rear as far as possible by means of the cocking handle and release it; the rifle is now ready to fire.

38. SETTING THE SIGHTS

To set the sight on the required graduation, press the slide catch, move the slide until it matches the required graduation on the sight leaf; release the slide catch.

The battle setting (indicated by the letter P) is used in concentrated periods of combat, when time does not permit setting the slide. This setting permits the destruction of targets up to 50 cm in height (chest target) at ranges up to 350 m; at ranges up to 300 m, it is necessary to aim at the lower edge of the target, and at ranges greater than 300 m the rifle must be aimed at the center of the target.

In firing at a range greater than 350 m, or when it is necessary to effect more accurate fire, it is necessary to set the slide on the graduation of the sight leaf that corresponds to the range to the target.

39. FIRING

The following is performed in firing:

Set the rear sight on the required range.

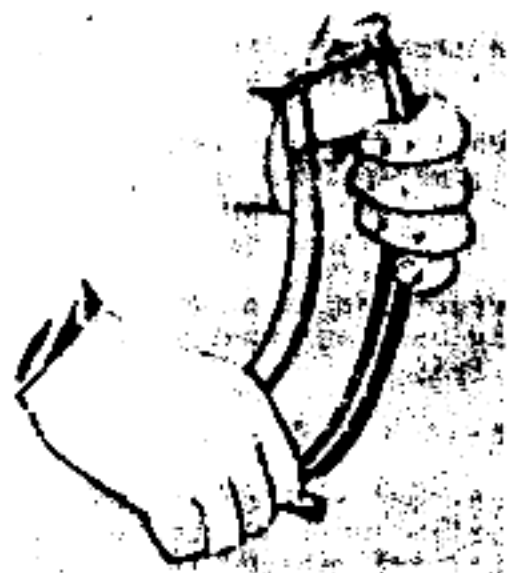

Figure 88. Loading the magazine.

Prepare for fire; in firing the rifle, the rifle is held by gripping the fore end ahead of the magazine with the left hand or gripping the magazine, and the pistol grip is held by the right hand.

Take aim and squeeze the trigger smoothly.

If the selector is set on automatic fire, the rifle will keep firing as long as the trigger is depressed and rounds remain in the magazine.

If the selector is set on semiautomatic fire, only one shot will be fired when the trigger is pressed. To fire the rifle, it is necessary to squeeze and release the trigger every time.

40. CHANGING THE MAGAZINE

To change the magazine: Remove the magazine from the rifle; remove a loaded magazine from the magazine bag; place the empty magazine into the magazine bag; attach the loaded magazine to the rifle.

41. CESSATION OF FIRE AND PREPARING THE RIFLE FOR FURTHER FIRE

The rifle can cease firing due to:

1. Failure of the mechanisms. To eliminate the cause, follow the instructions in Chapter 6, Section 45.
2. Absence of rounds in the magazine. To continue firing, it is necessary to reload the rifle.
3. Command to cease fire or accomplishment of mission.

To cease fire, it is necessary to release pressure from the trigger; in this case the operating rod remains in the forward position, a round will be in the chamber, and the hammer will be cocked. The rifle is ready for further firing.

42. SETTING THE RIFLE ON SAFETY

When firing is not being conducted (after cessation of fire, in travel and training, and also when the rifle is stacked) the rifle must be set on safety.

To set the rifle on safety, the selector indicator must be turned upward as far as possible.

If the rifle is unloaded, before the selector is set on safety, the hammer must be released.

43. UNLOADING THE RIFLE

To unload the rifle:

Detach the magazine from the rifle.

Remove the round in the chamber, pulling to the rear the operating rod using the hand.

Release the hammer by pressing the trigger.

Set the rifle on safety.

Set the rear sight on battle setting by pulling the slide to the rear as far as possible.

CHAPTER 6

CAUSES OF FAILURE OF THE RIFLE

44. GENERAL PROCEDURE FOR PREVENTING AND ELIMINATING STOPPAGES

With proper maintenance, storage and handling, the automatic rifle is reliable in use. However, as a result of careless handling, dirty parts, low-grade rounds, and also as a result of wear of the parts caused by extensive use, normal operation of the rifle can be affected, causing stoppages during fire. The majority of stoppages can be easily eliminated simply by cocking the rifle, that is by bringing to the rear the operating rod and releasing it.

To prevent stoppages:

1. Prepare the rifle for firing properly.
2. Inspect, clean and lubricate the rifle.
3. Carefully observe the cleanliness and operation of the operating rod, bolt, bore, gas channels and magazines.
4. Perform timely maintenance.
5. Carefully inspect ammunition before firing.
6. Fire only serviceable and clean ammunition.
7. Protect the rifle from dirt and blows during fire and travel.
8. In combat, clean the gas port in the barrel, the gas tube, and the piston, and lubricate lightly the working surfaces of the parts, at every possible opportunity.
9. Disassemble and clean the rifle whenever it is excessively dirty. If the rifle is used in extremely cold weather a considerable period of time, before loading it is necessary to move the operating rod forward and rearward several times manually.

If a stoppage occurs in fire, recock the rifle immediately manually and continue firing; if recocking the rifle does not eliminate the stoppage, it is necessary to ascertain the cause and eliminate the stoppage.

45. CHARACTERISTIC MALFUNCTIONS AND METHODS FOR CLEARING THEM

A list of the most common malfunctions is given in the following table, together with the general causes of the malfunctions and the simplest methods that may be employed to clear them.

Malfunction	Causes	To clear
<p>1. Failure of magazine to feed rounds.</p> <p>The moving parts move to the extreme forward position, the round is not fired, and there is no round in the chamber.</p>	<p>Magazine not properly attached. Dirty or defective magazine. Defective magazine catch.</p>	<p>Recock the rifle and continue fire; if the malfunction occurs again, replace the magazine. If the magazine catch is defective, send the rifle to the repair shop.</p>
<p>2. Empty cartridge case not extracted from chamber.</p> <p>Cartridge case remains in chamber, the following round jams against the cartridge case. Moving parts remain in center position.</p>	<p>Dirty rounds or chamber. Defective extractor or weak extractor spring.</p>	<p>Cock rifle and remove cartridge case from chamber with cleaning rod. Clean rounds and chamber, and inspect extractor. If extractor is serviceable, continue firing. If extractor is unserviceable, send rifle to repair shop.</p>
<p>3. Jamming of cartridge case.</p> <p>Cartridge case not extracted from receiver, but is jammed between bolt and barrel, or between bolt and receiver, or is rammed back into chamber.</p>	<p>Dirty moving parts, gas port or chamber. Defective extractor or extractor spring.</p>	<p>Pull bolt to rear, extract jammed cartridge case and continue firing. Clean and lubricate rifle at first opportunity. If extractor or extractor spring is defective, send rifle to repair shop.</p>

Malfunction	Causes	To clear
<p>4. Jamming of round.</p> <p>The bullet end of the round jams against the barrel as the bullet moves forward.</p>	<p>Excessive play of magazine, bent magazine flanges.</p>	<p>Pull operating rod to the rear and, retaining it by means of the cocking handle, remove the jammed round and continue firing. If jamming occurs again, replace magazine.</p>
<p>5. Misfire.</p> <p>Bolt in forward position, hammer released, but round not fired.</p>	<p>If the primer shows deep dents caused by firing pin, primer is defective. If slight dent is found in primer, defect lies in firing pin or firing and trigger mechanism.</p>	<p>Recock rifle and continue firing. If stoppage occurs often, inspect and clean firing pin and firing and trigger mechanism. Pay particular attention to full automatic sear. If parts are broken or defective, send rifle to repair shop.</p>

CHAPTER 7

CHECK OF ACCURACY AND ADJUSTMENT OF AUTOMATIC RIFLE

46. PROCEDURE FOR ADJUSTING RIFLE

The accuracy is checked:

1. When the rifles arrive at the using units;
2. After replacing the front sight or after repair of the rifle;
3. When abnormal fire dispersion is discovered during fire.

The best riflemen of the unit must be selected to fire the rifles for the purpose of checking accuracy. The riflemen are detailed by the company commanders. The rifles are fired in the presence of the soldiers to whom the rifles are assigned, and in the presence of their commanders.

Before firing for testing accuracy, the rifle must be carefully inspected and all defects must be eliminated. The armorer-artificer must be present at the firing range.

Firing for testing accuracy must be performed under favorable conditions: in clear, calm weather, in a protected rifle range, or on a portion of a rifle range which is protected from the wind. The rifles are fired for accuracy using ball ammunition at a range of 100 m with the rear sight set on graduation 3.

The target in this case is a black rectangle 35 cm high and 25 cm wide, fastened on a white board 1 m high and 0.5 m wide. The aiming point is the center of the lower edge of the rectangle; it should be located approximately at the height of the head of the soldier firing the rifle. A point located above the aiming point on the vertical line which characterizes the normal position of the center of the impact, which should be above the aiming point by 28 cm, is marked using chalk or pencil.

The point thus marked is the control point.

The rifle is fired in the prone position using a support. The support may be a bag which is filled with sawdust, earth, or sand.

In this position, the left arm of the rifleman, which is supporting the rifle, should be on top of the support.

Four single shots are fired while carefully and uniformly aiming at the lower edge of the black rectangle, and the position of the rifleman's body and left hand must not change.

When fire ceases, the commander inspects the target and determines the accuracy of the rifle and the position of the center of impact on the basis of the location of the bullet holes. The accuracy of the rifle is considered to be acceptable if all four bullet holes, or at least three holes, if the fourth hole is located quite a distance away from the remaining holes, are grouped in a circle with a diameter of 15 cm, and if the center of impact deviates from the control point no greater than 5 cm in any direction.

If the accuracy does not satisfy this condition, the company commander must inspect the rifle, check the sight setting, and repeat the fire. If an unsatisfactory result is obtained the second time, the rifle is sent to the repair shop for ascertaining and eliminating the causes of inaccuracy.

If the accuracy of the rifle is considered normal, the commander determines the center of impact and its position with respect to the control point.

To determine the center of impact from the four bullet holes (fig. 89):

1. Connect any two bullet holes with a straight line and find the center of the distance between them.
2. Connect the points thus obtained with the third hole, and divide the distance between them into three equal parts.
3. Connect the point of division closest to the two first holes with the fourth hole, and divide the distance between them into four equal parts. The point which is located three divisions from the fourth hole is the center of impact.

If the bullet holes are located symmetrically, the center of impact may be determined by one of the following two methods:

1. Connect the bullet holes located closest together; the centers of both straight lines are to be connected with the third line, and the line thus obtained is to be divided in half; the dividing point is the center of impact.
2. The bullet holes are connected with intersecting straight lines; the intersection of these lines is the center of impact.



Figure 89. Determination of center of impact by the graphical method.

I - measurement of four holes; II and III - measurement of four symmetrically located holes.

If one of the holes is located a large distance from the remaining holes, it is not considered, and the center of impact is determined from the three holes.

In this method, two holes are connected by a straight line, the center of this line is connected with the third hole, and the new line is divided into three equal parts; the point located two divisions from the third hole is the center of impact.

The center of impact should coincide with the control point or deviate from it no more than 5 cm in any direction.

If the center of impact deviates more than 5 cm from the control point, the armorer-artificer adjusts the rifle by moving the front sight to the right or left or up and down, depending upon the direction in which the center of impact deviates.

It must be borne in mind that the front sight must be moved in the direction in which the center of impact deviates.

If the center of impact deviates to the left of the control point, the front sight must be moved to the left; if deviation is up, the front sight must also be moved up (using screw-driver).

The amount of displacement of the front sight is determined by multiplying the amount of deviation of the center of impact from the control point as measured on the target by the correction factor.

The correction factor for the AK automatic rifle with given conditions (range to target 100 m, range setting 3, length of sighting line 378 mm) is 0.0378.

EXAMPLES:

1. The center of impact deviates from the control point to the right by 12 cm, and 10 cm low.

In order for the center of impact to coincide with the control point, the front sight must be moved to the right 0.0378×12 equals 0.4536 mm, is approximately equal to 0.5 mm, and low by 0.0378×10 equals 0.378 mm, is approximately equal to 0.4 mm.

2. The center of impact deviates from the control point to the left 19 cm and 15 cm up. The front sight must be moved to the left 0.0378×19 equals 0.7182 mm, approximately equal to 0.7 mm, and up 0.0378×15 equals 0.5670 mm, approximately equal to 0.6 mm.

NOTE: The amount of deviation of center of impact in cm is multiplied by the correction factor and the result is obtained in mm.

After the position of the front sight is corrected, the rifle is checked for accuracy once more.

Moving the front sight laterally one millimeter displaces the center of impact by 26 cm at a range of 100 m; screwing in (screwing out) the front sight the amount of one turn raises (lowers) the center of impact 20 cm. When the rifle is adjusted, a new graduation line is entered on the front sight slide and the old graduation line is obliterated.

It is forbidden to obliterate graduation lines in the base of the front sight.

After the rifle is adjusted, the results and time of accuracy check are entered into the gun data card of the rifle (see Appendix II).

47. CHARACTERISTIC DEFECTS OF THE RIFLE AFFECTING ACCURACY

Deviation of the center of impact during fire can be caused by the following causes:

1. Rear sight leaf bent causing the bullets to deviate in the direction in which the sight is bent; the rifle must be sent to the repair shop and rechecked for accuracy after repair.

2. Front sight slide displaced to the side, causing the center of impact to deviate in the direction opposite that of the displacement of the slide (displacement of the slide is determined by the position of the alignment lines on the slide and the front sight base); the front sight slide is set even with the line on the front sight base and then the rifle is checked for accuracy.

3. Front sight slide insecurely installed; the rifle must be sent to the repair shop.

4. Loosening of the front sight; in this case, the center of impact will be deviating in the direction opposite that of the sight displacement (upward when sight unscrews and downward when sight lowers); the front sight must be removed in order to widen the leaves; if the front sight is not held firmly, it must be replaced; after all these operations, the rifle must be checked for accuracy.

Excessive dispersion may be caused by the following:

1. Large play of rear sight leaf; the notch keeps shifting when the rifle is fired to cause dispersion.
2. Muzzle face dented.
3. Excessive play of stock (of rifles with folding metal stock).

The serviceability of the rifle must be determined by careful inspections, check of caliber, and fire for accuracy, if any of the above irregularities are present.

CHAPTER 8

CLEANING AND LUBRICATION OF THE AUTOMATIC RIFLE

48. CLEANING AND LUBRICATION OF AUTOMATIC RIFLES IN USE

General

The rifle must be kept clean at all times. Cleanliness is attained by timely and proper inspection, cleaning, and lubrication. Cleaning of rifles in use in units is performed:

1. In field of combat, on maneuvers and extended training in the field--daily (a lull in combat or break in training is utilized).
2. After firing service and blank cartridges-- immediately upon completing the fire; it is necessary to apply the alkali solution, wipe dry and lubricate the bore, gas cylinder, gas tube, piston and bolt immediately at the firing range (in the field); upon returning from the firing range, the rifle must be cleaned completely; cleaning must be repeated for the following three or four days.
3. After training, guard duty and exercises (even though the rifle is not fired)-- immediately after completing duty.
4. If the rifle is not fired or used--not less than once every seven days.

NOTE: It is strictly forbidden to leave alkali solution in the bore, gas cylinder, gas tube or bolt face, since this will cause rapid rusting of the metal.

The rifle is lubricated immediately after cleaning.

The rifles are cleaned and lubricated under the supervision of officers and sergeants, who must:

1. Determine the degree of disassembly, cleaning and lubrication required.
2. Check the condition of the accessories and the cleaning materials used.
3. Check the rifle for cleanliness, and then give permission to lubricate.

4. Check the lubricated rifle and give permission to assemble the rifle.

5. Check the assembled rifle and give permission to replace the rifle in the rack.

In permanent installations, the rifles are cleaned in places which are specially prepared for cleaning; in the field, the rifles are cleaned in places which are prepared by laying down boards, canvas, etc.

The materials for cleaning must be in good condition, and the lubricating materials must be of good quality. The lubricating materials must be stored in the proper cans, and the cloths in bags. Lubrication in storage must be kept in closed containers in storage buildings, and the cloth materials must be kept in special cases or must be tightly wrapped.

For cleaning, wiping and lubrication of the rifle, use a clean and soft patch and hemp fiber from which the scutch is removed. The hemp fiber is used for cleaning the bore.

To clean and lubricate the rifle, use the following lubrication and cleaning compositions:

1. Alkali solution; removes fouling from the bore and other parts of the rifle which come into contact with the gases.

2. Rifle lubricating oil; this is used for lubricating all metal parts, and is effective at a temperature of plus 50 degrees to minus 5 degrees C (122°F to 23°F).

3. Winter lubrication No. 21; this is used for lubricating rifles which are in use in winter, both in preparation for fire and in lulls in fire.

The above lubrication must not be used in summer, since it is not sufficient protection from corrosion. It is forbidden to heat lubrication No. 21, since when heated to a temperature of 80 to 100 degrees C (176°F to 212°F), it decomposes and becomes unsuitable for use.

Winter lubrication No. 21 is effective for use in the mechanisms of the rifle at a temperature of minus 5 to minus 40 degrees C (23°F to minus 40°F). At a lower temperature, from 10 to 20% of dehydrated kerosene must be added to it (diluting lubrication No. 21 with kerosene improves the operation of the mechanisms but decreases anti-corrosive properties).

4. Gun oil; used to lubricate the rifle prior to extensive storage; it is used mixed with rifle lubricating oil (50% gun oil and 50% rifle lubricating oil).

5. Kerosene of good quality which is first filtered with calcined table salt; used to remove old lubrication from rifle (after storage), for softening rust, and also for diluting winter lubrication No. 21.

Kerosene may be used only in the artillery repair shop.

It is not permitted to use any other lubrication and cleaning solutions.

The use of lubrication and cleaning solutions has a useful purpose only in the event that proper maintenance and lubrication of the rifle are performed. Without observing these conditions, the lubrication will not be effective in protecting the rifle, and in some instances incorrectly used lubrication or non-standard lubrication and solutions may cause failure of the rifle, especially at low temperatures.

Procedure for Cleaning and Lubrication

To clean the rifle after firing, exercises, classes and duty detail, the rifle must be field stripped.

The rifle must be detail stripped to remove storage lubrication, when replacing or repairing parts, when the rifle is very dirty, or after excessive exposure to moisture.

NOTE: The firing and trigger mechanism of rifles with stamped metal receiver of earlier manufacture is disassembled only when replacing or repairing parts in the artillery repair shop.

To clean the bore, the accessory case must be attached to the cleaning rod as follows:

1. Insert the cleaning rod through the large hole in the case so that its head passes inside the case and butts against its wall.

2. Insert the screw-driver into the case above the cleaning rod head.

3. Install the accessory case cap on the cleaning rod.

4. Install the jag or brush on the threaded end of the cleaning rod.



Figure 90. Cleaning rod prepared for cleaning the bore.

When using the tool as a key for removing or installing the front sight, the screw-driver blade is inserted into the notches in the accessory case (through the long notch and the short notch) (fig. 91).

When using the tool as a screw-driver, the key is inserted into the accessory case notches (through the long notch into the short notch) (fig. 92).

To clean the bore, it is necessary to form the hemp fiber into a figure eight and immerse it into the alkali solution, and install the hemp fiber on the face of the jag (see fig. 90) in such a manner that its ends do not hang further than the rotating part of the jag. Then introduce the cleaning rod into the bore through the muzzle end to a depth of approximately one third the length of the barrel; install the accessory case cap on the muzzle part of the barrel; rest the butt plate against an object (fig. 93), grasp the barrel with the left hand, and grasp the accessory case (cleaning rod handle) with the right hand, and move the cleaning rod back and forth throughout the entire length of the bore 7 to 10 times; then replace the hemp fiber with other hemp fiber saturated with alkali solution and repeat the process. Dry the bore thoroughly using a patch (after carefully wiping the cleaning rod, jag and accessory case cap) and, if there are traces of fouling or rust on the patch, repeat the cleaning using the hemp fiber saturated with alkali solution, and then use a dry white patch. Repeat this operation until a dry white patch shows no traces of fouling.

The same procedure is to be employed to clean the chamber, gas cylinder, and muzzle face. After cleaning the bore, chamber, and gas cylinder, inspect the bore through the muzzle end while rotating the rifle. To improve illumination, insert a piece of white paper into the receiver.

NOTE: A barrel in which there is an erosion pattern must be cleaned especially carefully, and all the erosion must be removed.

After the bore and chamber are cleaned, they are lubricated with a uniform thin layer of oil, using the brush dipped in rifle lubricating oil. If the brush is unsuitable, it is permitted to lubricate the bore using the patch dipped in rifle lubricating oil.

The exterior surface of the barrel (the areas under the hand guard, fore end and rear sight base) should be cleaned with a patch soaked in alkali solution and wrapped around the end of a small wooden stick.

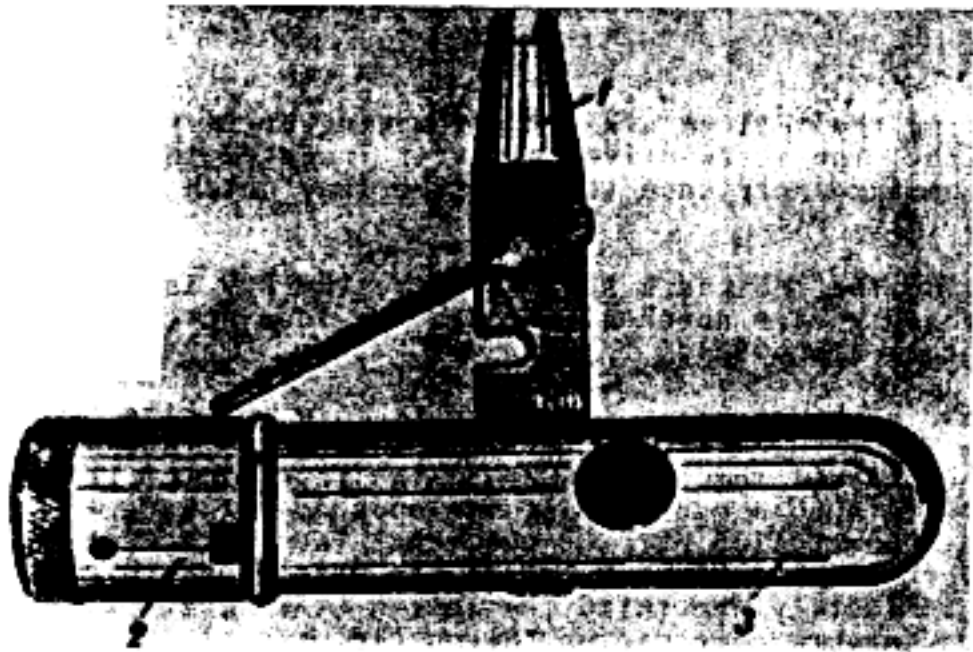

Figure 91. Combination tool prepared for removing the front sight.

1 - combination tool; 2 - accessory case cap; 3 - accessory case.

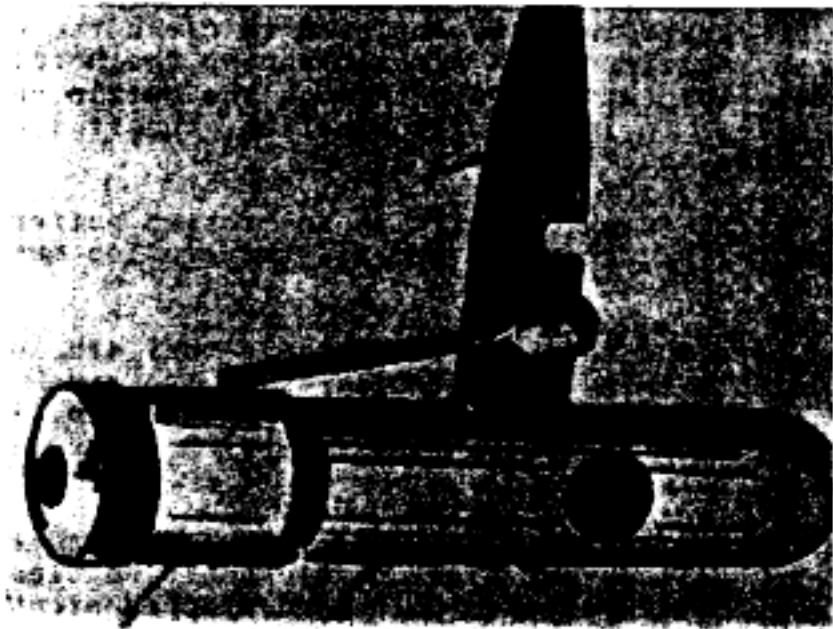

Figure 92. Combination tool prepared for removing screws.



Figure 93. Cleaning the bore.

If the rifle has been fired, the gas cylinder and gas tube should also be cleaned with a patch soaked in alkali solution until all carbon deposits are removed, after which the parts should be dried with a patch wrapped around the wooden stick or around the jag. The gas port should be cleaned with a reamer.

After firing, the piston, the gas piston rod, bolt and operating rod are cleaned with a patch saturated with the alkali solution. It is forbidden to clean the operating rod channel in which the return mechanism is housed using the alkali solution; it must be wiped dry, using a clean patch and lubricated by applying a patch saturated with rifle lubricating oil.

If the rifle has not been fired, the gas cylinder, gas tube, piston, gas piston rod and operating rod must be wiped dry with a clean patch and lubricated.

If a hardened fouling is present in the above-indicated parts, apply the alkali solution to them and remove the solution after a period of ten to fifteen minutes; then clean and dry them thoroughly. The receiver, return mechanism, firing and trigger mechanism are wiped using a dry cloth; the holes, recesses and grooves are cleaned with a patch on the end of a sharp stick. After cleaning, the rifle parts must be covered with a thin layer of rifle lubricating oil.

NOTE: The firing and trigger mechanism and folding metal stock are not disassembled for cleaning and lubrication.

After cleaning, a check must be made that no patches are left in the gas cylinder, gas port, and operating rod channel.

It must be borne in mind that excess lubrication tends to collect dirt. In the summertime, moving parts must be lubricated more often than in winter.

The exterior surface of metal parts must first be wiped with a clean cloth and then with a cloth bearing a small amount of oil; wooden parts of the rifle are to be wiped, using only a dry cloth; it is forbidden to lubricate them with rifle lubricating oil.

To lubricate holes, recesses, and grooves, a clean patch must be wound on a wooden rod and dipped into oil.

If magazines were filled with rounds but the rifle has not been fired, wipe only the exterior surface of the magazines and apply a thin layer of lubricating oil; if the magazines were filled and the rifle was fired, the magazines must be disassembled, all the parts must be

wiped with a dry patch on the end of a sharp stick, and the feed mechanisms and followers wiped with a cloth dipped in the alkali solution, and then dried using a dry patch and coated with a thin layer of oil.

Upon completion of cleaning, the accessories must be wiped, inspected, assembled and inserted into the butt. After lubrication, the rifle is assembled, the operation of the parts in assembled form is checked, and the rifle replaced in the rack.

At low temperatures, it is advantageous to clean the rifle in a heated building. After the rifle is brought into a heated building, it is necessary to wait ten to fifteen minutes before cleaning in order for moisture to form on the rifle.

There is no necessity for waiting until the moisture formed on the rifle evaporates, since rust will form under each drop. This is especially important in the event the rifle is brought into a building for an extended period of time.

If the moisture is not carefully removed from the rifle, the rifle, when taken out into the cold, may malfunction as a result of ice formation on the parts.

Rifles which are subjected to rain or snow must be carefully cleaned. Old lubrication must be removed and fresh lubrication applied.

49. USE OF THE AUTOMATIC RIFLE IN WINTER

A rifle which is in use in winter must be lubricated using only winter lubrication in accordance with the instructions of the preceding section. It is forbidden to lubricate rifles which are not used using lubrication No. 21.

Before lubricating the rifle using winter lubrication No. 21, it is necessary to detail strip the rifle, and remove the rifle lubricating oil from all the parts and mechanisms, and then wipe them dry with a patch.

It is especially important to remove completely summer lubrication from the firing and trigger mechanism springs, the space between the full automatic sear and receiver wall, and the parts of the magazine.

The parts of the rifle must be lubricated with winter lubrication by applying a thin layer by means of a patch soaked in oil.

If the winter lubrication is applied in a thick coat, malfunctions may be caused during fire.

Lubrication No. 21 protects the metal from corrosion for only a short time (1 to 2 months). The oil cannot protect the metal for a longer period, especially in areas with high humidity and atmosphere saturated with various salts. Therefore, if the rifles are used seldom, it is necessary, not less than every 1 to 2 months, to inspect them, remove lubrication if necessary, dry the surfaces and apply fresh lubrication.

After bringing the rifle into a heated building from the cold, it must be permitted to "sweat"; the rifle must then be dried and all the parts lubricated.

If the rifle is in the cold or in snow a considerable period of time before fire, before loading the rifle it is necessary to move the operating rod back and forth several times by means of the cocking handle.

Check the position of the hammer while cocked, and pull the trigger to release the hammer from the cocked position.

50. USE OF THE AUTOMATIC RIFLE IN AREAS WITH HIGH TEMPERATURES AND SANDY TERRAIN

In training exercises, during marches and in combat in sandy terrain, it is necessary to adopt all measures for protecting the rifle and ammunition from dust.

During extensive use of the rifle in dusty terrain, the bolt and the guides in the receiver should be oiled frequently through the opening for the magazine and ejection port; the rifle need not be disassembled for this operation. Before reloading the rifle after each oiling, the functioning of the firing and trigger mechanism should be checked by pulling the operating rod to the rear and releasing it several times. In such dusty terrain, the opening in the receiver through which the magazine is inserted into the rifle should be uncovered only when changing magazines and during the periodic lubrication mentioned above. In combat, the slot for the cocking handle should be covered during lulls in fire by means of the selector cover plate, i.e., by setting the rifle on safety.

The rifle should be cleaned and lubricated after each extensive use. Special care should be taken in cleaning and oiling the working surfaces of the trigger and firing mechanism, bolt, operating rod, extractor, gas tube and magazine.

In combat, lack of time may make it permissible to fire the rifle without oiling it, but not without wiping the dust off all the parts. The rifle must be thoroughly cleaned and oiled at the first opportunity.

In hot weather, the rifle and especially the ammunition should be shielded as much as possible from the rays of the sun. Overheating of the rifle, and especially of the ammunition, may be the direct cause of stoppages.

51. CLEANING AND LUBRICATING RIFLES IN PREPARATION FOR EXTENDED STORAGE

Rifles to be cleaned in preparation for storage must be detail stripped. The usual cleaning procedures are to be observed, with special attention allotted to the removal of carbon deposits, dirt, moisture and rust from the bore, gas cylinder, gas tube, gas piston, and all grooves and holes.

To remove traces of rust and lubrication, it is suggested that the parts of the rifle be taken to an artillery repair shop and washed in kerosene, then dried thoroughly with a clean, dry patch; then lubrication must be applied immediately to protect the metal from moisture.

The dried parts must not be handled in the bare hands, since rust may form from perspiration. They must be handled using a clean patch or paper.

After being cleaned and dried, permission of the person in charge of cleaning must be obtained to lubricate the rifle.

Rifles which are to be stored for a prolonged period are to be lubricated with a mixture consisting of 50% rifle lubricating oil and 50% gun oil.

The wooden parts of the rifle are dried thoroughly and are not lubricated.

Rifles in storage (both new and used) are inspected and cleaned not less than once every two years; the oil in the bores must be changed at least once every two years, and fresh lubrication applied to exposed parts not less than twice a year (spring and fall).

CHAPTER 9

STORAGE OF AUTOMATIC RIFLES

52. STORAGE OF RIFLES IN UNITS

The rifles should always be in full combat readiness.

Storage of the rifle and its accessories is the responsibility of the soldier who must maintain the equipment properly and inspect it daily.

In permanent installations, the rifle is kept in the rack; the magazines are removed from the rifle, the hammer is not cocked, the safety is set, and the rear sight slide is set on the graduation P (pulled to the rear as far as possible).

Folding metal stocks are set in the folded position.

The magazines are stored unloaded in special compartments of the rifle rack or in cabinets. The magazine bags are stored together with the magazines.

Cleaning accessories of rifles with wooden butt are stored in the butt recesses, and the accessories of rifles with folding metal stock are stored in the magazine bags. In the camp, the rifles are stored in the rifle racks the same as in the permanent barracks.

In travel, the rifles are carried with attached but unloaded magazines, and in combat, with loaded magazines. The rifle must be set on safety. Spare magazines are carried in bags. When the troops are quartered in tents, the rifles are stored on a covering or in temporary racks. During a halt, the rifles are stored depending upon the situation, and must be protected from dirt, damage, etc.

If the troops are quartered in houses at a populated place, the rifles are stored with attached but unloaded magazines (loaded in combat) depending upon the type of building; the rifles are kept on a table, bench, or shelf, or are hung on nails or hangers by means of the sling.

In travel by railroad or water route, the rifles are kept in special places or are hung, if the situation permits.

In movement in motor vehicles, in armored carriers, the rifles are held between the knees to protect them from blows. In travel, the hammer must not be cocked, and the safety must be set.

53. STORAGE OF RIFLES IN DIVISION AND CORPS DEPOTS

As a rule, rifles which are in the reserve of the military units of corps level and lower are stored in division and corps depots.

The depots must be equipped so as to satisfy the requirements of the "Instructions for Storage and Care of Artillery Materiel and Ammunition by Using Troops."

It is not permitted to store rifles in boxes which are formed into stacks.

In rare cases, when no equipped storage places are available, rifles may be stored in boxes, but must be stored separately from the accessory equipment (slings, canvas bags, etc.) since this causes the formation of rust and deterioration of the accessory items; the permission of the Chief of the Department of Artillery Equipment of Military District (Group) must be obtained in this instance.

At the depot, the rifles are stored in rifle racks, with an individual compartment for each rifle. Before the rifles are stored in the rack, the magazines are removed, hammer released, safety set, and rear sight slide set on graduation P. The magazines are stored by the automatic rifles or on shelves; the accessories are stored in cabinets or on shelves.

Each rifle compartment is numbered. Above each rack there is a record of the automatic rifles indicating the unit to which the rifles are assigned, the rifle serial numbers, and the year of manufacture. In a box near the rifle rack are kept the data cards of the rifles with the following information entered: condition of the bore, date of assignment to unit, date and results of accuracy check, and category of rifles.

PART THREE

AMMUNITION

CHAPTER 10

SERVICE AND TRAINING AMMUNITION

54. GENERAL

The Kalashnikov automatic rifle fires the 7.62-mm round M1943.

The rounds have varying construction depending upon their purpose.

The weight of the bullets and their muzzle velocity are selected so that fire using the different bullets can be conducted with the same sight settings.

Ammunition is divided into service and auxiliary types.

55. SERVICE AMMUNITION AND ITS USE

Service ammunition is divided into ball cartridges and special purpose cartridges.

Ball ammunition is used to destroy enemy personnel.

Special ammunition, depending upon its construction, is designed for target indication and correction of fire, igniting fuel and highly inflammable objects, for destroying lightly armored targets, etc.

Tracer cartridges are designed for target indication, fire adjustment, signal purposes, and destroying personnel. Tracer bullets can ignite straw roofs, dry grass, dry leaves, etc. The path of the bullet is indicated by a red flame, which is easily seen in day or night. The flame can be seen from a distance of 800 meters.

AP-incendiary cartridges are used to ignite fuel (gasoline) and for destroying targets protected by thin armor plating at ranges of up to 300 meters.

Incendiary cartridges are used to destroy fuel (kerosene, gasoline) in iron tanks up to 3 millimeters thick, and also for igniting straw roofs, haystacks, and dry grass at ranges up to 700 meters. Incendiary cartridges also contain a tracer

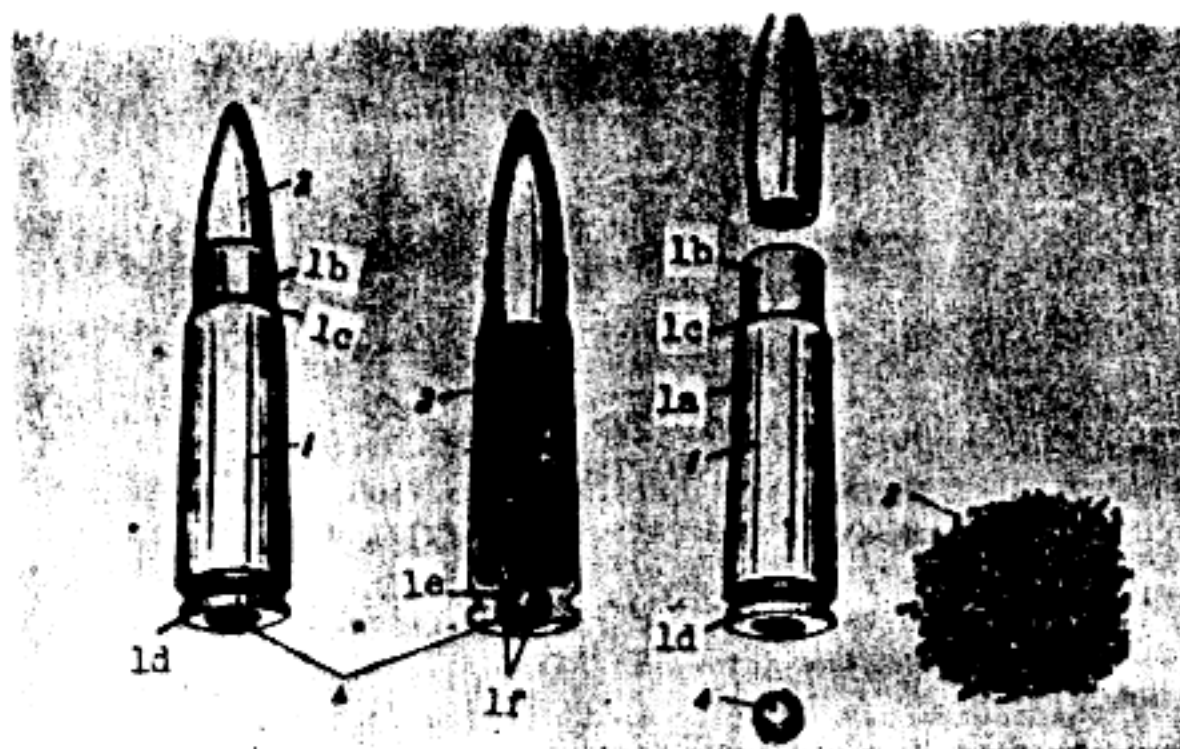

Figure 94. Service round. 1-cartridge case; 1a-body; 1b-mouth; 1c-shoulder; 1d-rim; 1e-anvil; 1f-vents; 2-bullet; 3-propellant; 4-primer.

element. The path of the bullet is indicated by a red flame which is easily seen in day and night. The trace can be seen from a distance of up to 700 meters.

56. CONSTRUCTION OF SERVICE AMMUNITION

The service round (fig. 94) consists of a cartridge case (1), bullet (2), propellant (3) and primer (4).

The cartridge case is made of steel plated with tombac.* The surface of the cartridge case is brass-plated or has only a lacquered finish.

The cartridge case consists of a body (1a) containing a propellant of smokeless pyroxylin powder, mouth (1b), shoulder (c), rim (1d).

In the base of the cartridge case there is a recess for the primer, and anvil (1e); and two vents (1f) through which the flame from the primer passes to ignite the propellant.

The primer consists of a brass cap containing compressed powder, and metal foil which seals the powder. The weight of the ball cartridge is 16.2 grams.

The bullets have varying construction depending upon their use (fig. 95).

The bullet in the ball cartridge M1943 consists of a steel tombac-plated jacket (1a), lead sleeve (1b) (lead and antimony alloy) and steel core (1c).

The bullet is fastened in the cartridge case by crimping or rolling the cartridge case mouth. The weight of the bullet is 7.9 grams. The nose of the bullet is not painted.

The tracer bullet M1943 consists of steel tombac-plated jacket (2a), lead core (2b) which is pressed into the nose of the sleeve, steel tombac-plated cup (2c) containing tracer element (2d) and ignition composition (2e), and ring (2f) to direct the gases. The bullet weighs 7.5 grams. The nose of the bullet is painted green.

The AP-incendiary bullet M1943 (type B2) consists of a sealed tombac-plated jacket (3a), tombac cap (3b), lead sleeve (3c), steel core (3d), and lead base filler (3e), and incendiary (3f). The bullet weighs 7.7 grams. The nose of the bullet is painted black and red.

* Tombac, which is usually 89% copper and 11% zinc, is commonly called gilding metal in the United States.

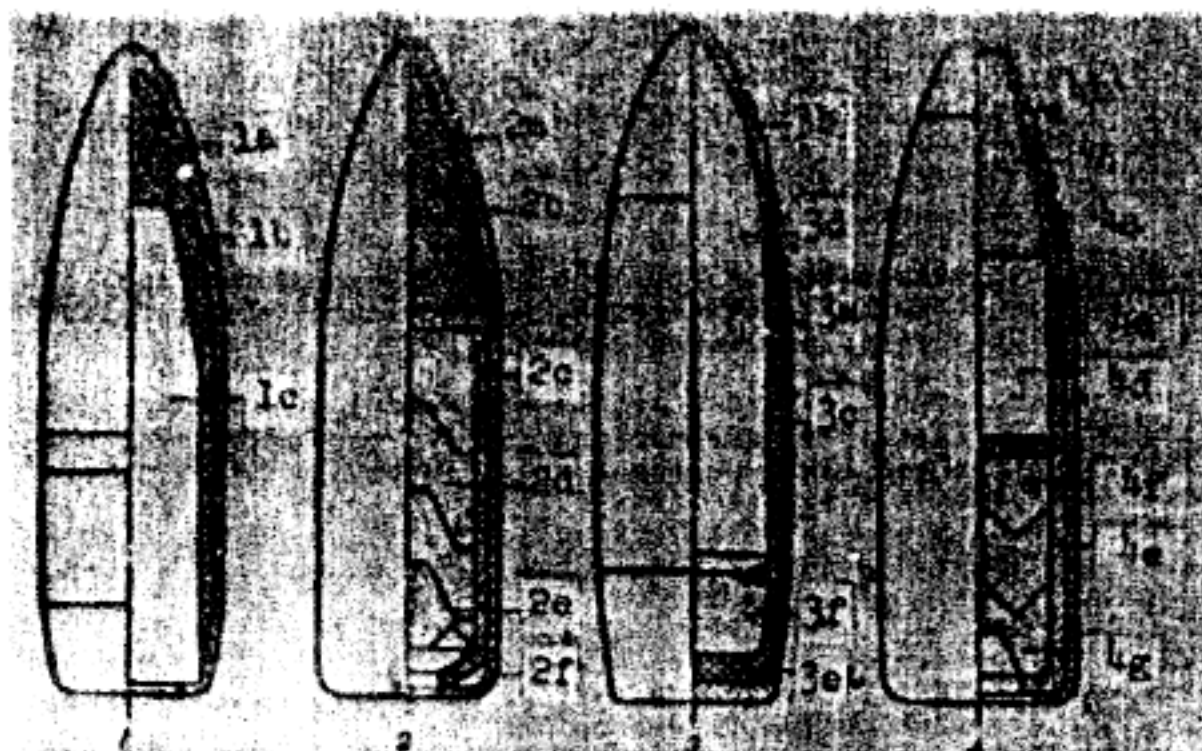

Figure 95. Bullets.

1 - bullet of ball cartridge; 1a - jacket; 1b - lead sleeve; 1c - core; 2 - tracer bullet; 2a - jacket; 2b - lead core; 2c - cup; 2d - tracer element; 2e - ignition composition; 2f - ring; 3 - AP incendiary bullet; 3a - jacket; 3b - cap; 3c - lead sleeve; 3d - core; 3e - base filler; 3f - incendiary composition; 4 - incendiary bullet; 4a - jacket; 4b - cap; 4c - lead sleeve; 4d - core; 4e - cup; 4f - tracer

The incendiary bullet M1943 (type Z) consists of a steel tombac-plated jacket (4a), tombac cap (4b), lead sleeve (4c), steel core (4d), steel tombac-plated cup (4e) containing tracer element (4f) and ignition composition (4g); in the nose of the bullet is located the incendiary composition (4h). The bullet weighs 6.6 grams. The nose of the bullet is painted red.

57. ACTION OF SPECIAL PURPOSE BULLETS

Action of Tracer Bullet

At the instant of firing, the ignition composition is ignited by the gases. After the bullet leaves the bore, the ignition composition ignites the tracer element.

Action of the AP-Incendiary Bullet

The bullet perforates armor upon impact due to its core. The incendiary composition is ignited by the impact. The fire produced ignites the fuel.

Action of Incendiary Bullet

At the instant of firing, the incendiary composition is ignited by the gases. When the bullet leaves the bore, the incendiary composition ignites the tracer element.

When the bullet strikes the target, the incendiary composition is ignited by the impact and bursts the tombac cap and bullet sleeve. The flame thus produced easily ignites highly inflammable objects. In the event the tracer element has not burned completely in flight, the burning of the tracer element also serves to ignite objects.

58. TRAINING AMMUNITION, PURPOSE AND CONSTRUCTION

Training ammunition includes drill and blank 7.62-mm rounds M1943.

Drill rounds are designed for training in loading and firing. On the body of the cartridge case there are longitudinal grooves, and on the cartridge case mouth there are marks from the clamping device. The primer is pierced. There is no propellant in the cartridge case.

Blank cartridges are designed for simulating fire and are used in tactical exercises. There is no bullet in the blank cartridge. The mouth is sealed by a star (rosette crimp). It is forbidden to stand closer than 10 meters away from the muzzle face when blank cartridges are being fired.

PACKING AND STORAGE OF AMMUNITION

59. PACKING OF AMMUNITION AND MARKINGS ON PACKAGING

Ammunition is delivered to the using units in wooden boxes, each containing two cases made of zinc-plated iron containing the rounds. On the side of the box is a stencil giving the following data:

1. Caliber of round, model of bullet, cartridge case metal.
2. Number of rounds in box.
3. Lot number of rounds and number of manufacturer.
4. Month and year of manufacture of rounds.
5. Type of powder.

Fig. 96 shows the stencil for 7.62-mm ball ammunition M1943, and for 7.62-mm tracer ammunition M1943. The figures and numbers in the stencil are interpreted as follows:

7.62 PS (or T-45) GZh M43; 7.62 is the caliber of the round; PS (T-45) abbreviated designation of the bullet (PS is ball ammunition with steel core; T-45 is tracer bullet); GZh means steel cartridge case; M43 is the model number.

The designation P29 (R14) is the lot number of the rounds; 3 (711) is the number of the manufacturer.

VIII-51 (VII-50) is the month and year of manufacture.

VUFL is the powder type; 17 is the powder lot; 50 is the year of manufacture of the powder; and K the manufacturer.

A colored stripe is painted on the boxes containing special purpose ammunition.

If the rounds are in clips, the words "In Clips" are also stenciled on the box.

In addition, on the top of the box for any type of ammunition are indicated the class of load, danger sign, and total weight of box.

7.62 ПС ГЖ
 ОБР. 43
 В ПИИМАХ
 1320 шт

П 29-3
 VIII-51
 ВУФЛ 17
 50 К

7.62 Т-45 ГЖ
 ОБР. 43
 1320 шт

ЗЕЛЕНАЯ ПОЛОСА

П 14-711
 VII-50
 ВУФЛ 17
 50 К

Figure 96. Marking of ammunition boxes.

For example, class XIV denotes that the load is non-explosive, sensitive to fire, and relatively insensible to mechanical blows. On the base of the cartridge case of all rounds there is a stamping, the upper figure of which denotes the number of the manufacturer and the lower the year of manufacture of the rounds.

There are 660 rounds to each zinc-plated case without clips, or 460 in clips. The cases are packed in wooden boxes (two cases per box); in each box there are 1,320 rounds without clips and 920 rounds in clips. The loaded box weighs 29 kg (63.93 lbs.).

On the lid of each case there is a stencil indicating the caliber of round, model of round, cartridge case metal, lot number of round, number of manufacturer, and powder type.

The rounds are packed in the zinc-plated cases in cardboard containers. There are 20 rounds to each cardboard container. There are distinguishing stripes painted on the zinc-plated cases and cardboard containers.

Table of Distinguishing Stripes on Boxes, Cases, and Cardboard Containers

Designation of Round	Abbreviated Designation	Distinguishing Stripes on Boxes
7.62-mm rounds, ball, M1943	ПС	None
7.62-mm rounds, tracer, M1943	Т-45	Green stripe
7.62-mm rounds, AP-incendiary, M1943	БЗ	Black and red stripes
7.62-mm rounds, incendiary, M1943	З	Red stripe

60. STORAGE OF AMMUNITION

The ammunition must be protected from moisture, snow, dust, and dirt. Moist rounds may rust in several days and become unserviceable.

The rounds must not be allowed to come in contact with any liquid, since the liquid will enter the cartridge case

and moisten the propellant, thus causing misfires or hang-fires; in such case the bullet may stick in the bore. Rounds must be stored in buildings which are protected from the elements, whether in the factory packing or loose.

If rounds must be stored in the open, they must be protected from rain, sun, dust, and snow. It is not permitted to build a fire near the ammunition.

The ammunition boxes must not be placed immediately on the ground, but on some covering, with the lids upward. It is not permitted to store lubricating and cleaning materials, or foreign objects, together with rounds.

The hermetical seal of the can is broken only when necessary. The distinguishing packaging marks must be heeded before opening the packing.

Drill and blank rounds are stored separately; it is strictly forbidden to store them together with service ammunition.

Rounds which are rusted must be dried with a wet patch. Rounds which are loose must be wiped before being loaded into the magazines. It is not permitted to fire unserviceable ammunition.

It is not permitted to throw ammunition boxes on the ground from vehicles and platforms. It is strictly forbidden to cut open rounds and bullets, strike the rounds with a hammer or other hard object, throw the rounds into a fire, or use the rounds for assembly or disassembly of the rifle (especially special purpose rounds).

APPENDIX I

TABLE OF CHARACTERISTICS OF KALASHNIKOV AUTOMATIC RIFLE WITH
WOODEN STOCK

All the characteristics of the automatic rifle with metal stock (weight and dimensional characteristics) are the same as those of the automatic rifle with wooden stock. The automatic rifle with metal stock has a length of 645 mm (25.39 inches), with the stock folded.

Characteristic	Amount
Weight of automatic rifle with magazine and accessories, kg (lb)	4.3 (9.479)
Weight of magazine, empty, kg (lb)	.42 (.9259)
Weight of magazine, loaded, kg (lb)	.920 (2.028)
Weight of automatic rifle with loaded magazine, kg (lb)	4.80 (10.58)
Length of automatic rifle, overall, mm (inches)	870 (34.251)
Length of barrel, mm (inches)	415 (16.338)
Length of rifled portion of bore, mm (inches)	369 (14.527)
Length of sighting line, mm (inches)	378 (14.881)
Capacity of magazine, rounds	30
Rate of fire, rounds/minute	600
Muzzle velocity, ball cartridge, m/sec (ft/sec)	710 (2329.38)
Weight of bullet, ball cartridge, grams (grains)	7.9 (121.9156)
Weight of ball cartridge, grams (grains)	16.2 (250.0042)

APPENDIX II

GUN DATA CARD NO. _____

Designation and Number of Weapon* _____
(The full designation is not written)

Manufacturer _____

Year of Manufacture _____

Designation of using unit _____

Assigned to _____
(surname and initials)Classification as Non-serviceable _____
(Authority)

Defects at time of issue	Date of accuracy check	Results of accuracy check	Signature of officer supervising accuracy check	Changes in condition of weapon discovered in inspection		Remarks
				Squad leader	Chief of Artillery Material	
Barrel without defects. First category. Chief of Artillery Material, Capt. (Signature) (Date)	(Date)	Normal	Company Commander (Signature)		Gage K-2 enters a distance of 2 mm from muzzle face. (Signature) (Date)	

*The abbreviated designation of the weapon is shown, for example "7.62-mm automatic rifle", since the card is not secret.